

STILTECH

EXPANDED MESH



ARCHITECTURE LINE

# FOCUS ARCHITECTURE





The aim of this publication is to confirm and strengthen the professional presence of ITALFIM a leading European producer of expanded metal mesh based in Italy in the construction and architecture sectors.

The expanded mesh produced by the Longhi Group can be considered truly "GREEN". We are committed to minimising the environmental impact of all our processes: responsible use of resources, waste separation, recycling and low energy consumption. For production in harmony with the environment.  
**Since 1948.**

## ATTENTION TO DETAIL



### ***Details are a priority***

*The Italfim STILTECH line: a range of expanded metal mesh for architectural cladding. Add character and originality to your design. Transparent and luminous materials ideal for design projects that enhance the natural local landscape as well as the urban or industrial setting.*

### ***Evolved design***

*Energy efficient buildings with improved sun light control and the comfort of natural light. All possible with expanded metal mesh.*

### ***Free shapes, yet safe***

*Modular design, made-to-measure, without shape or size restrictions. Fitness for purpose and Aesthetics. Mix and match the colours, create contrast or a uniform look.*



4

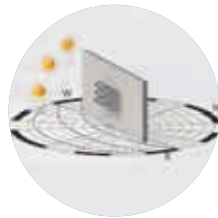

6  
NATURAL LIGHT CONTROL



8  
PROTECTION



11



12



14



18



22



24



26



28



30



32



34



36



38



40



44



46



48



50



52



54



56



58



60

**OUTFITTING  
AND DESIGN**

**63**



**64**



**66**

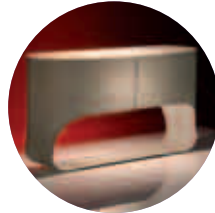

**68**



**69**

**PANELS FOR  
SUSPENDED CEILINGS**

**71**



**72**



**74**



**76**



**77**

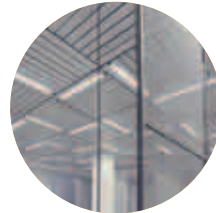

**78**



**79**



**80**

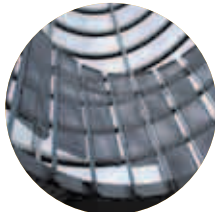

**81**



**82**



**89**

**PARAPETS  
AND FENCES**

**91**



**92**



**94**



**95**



**96**



**97**



**98**



**99**

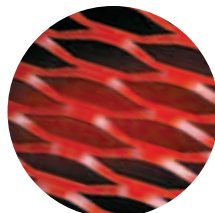

**100**

COLOURS AND FINISHES

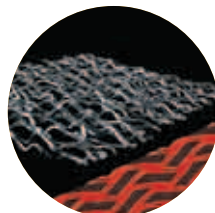

**102**

INNOVATIVE SOLUTIONS

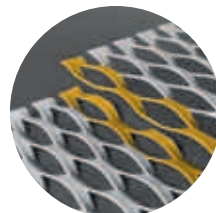

**106**

MODULARITY

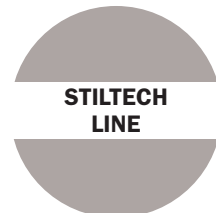

**STILTECH  
LINE**

**109**



### **Ecologically-sustainable material**

Longhi Group expanded metal is greener and greener! Constant commitment to limit the environmental impact of all processes through the responsible use of resources, differentiated waste collection, recycling, and energy consumption.



### **Corporate responsibility**

All production phases take place in Italy; personnel are protected by law. Workplaces are monitored, safe, and scrupulously comply with all the regulations in force.

## RESPECT FOR THE ENVIRONMENT

THE ARCHITECTURE OF THE FUTURE REQUIRES  
ENVIRONMENTALLY FRIENDLY PRODUCTION  
PROCESSES AND MATERIALS



### Green energy

70% of the energy required for our production is obtained from our photovoltaic system.

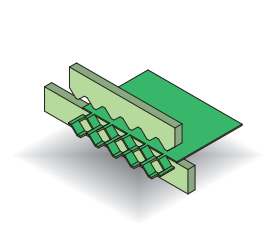

### Pollution-free process

“Expanding” is a cold-pressing process that does not require the use of pollutants.

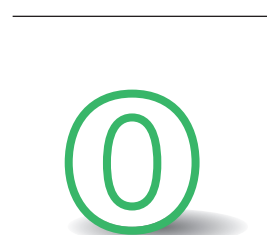

### Zero-scrap process

Expanded metal is produced without any work scrap with the optimized use of raw materials.

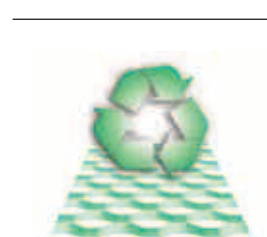

### Recycle

At the end of its long working life, expanded metal is subjected to differentiated waste collection for 100% recycling.

---



100% Made in Italy

## THE ADVANTAGE OF SOLAR LIGHT CONTROL

DESIGN SUSTAINABLE ENERGY-EFFICIENT BUILDINGS  
BY BETTER CONTROLLING THE ENERGY INFLOW  
THROUGH THE FAÇADE CLADDING

### Wellness through natural light

With the comfort of natural light, human productivity increases. In schools, offices, and workplaces. Daylight brings another important benefit: a reduced need for artificial illumination. Brightness can be adjusted using sliding brise-soleil.



### Natural environment and landscape

The transparency of expanded metal provides a view of the landscape and a more comfortable feeling. Nature is often less visible in the urban environment; this is the reason behind “vertical green” solutions: expanded mesh can create a metal support for plants.



### Energy savings and design

“Intelligent shade” limits the flow of heat and reduces the need for air-conditioning in the warmer months. The wide range of mesh patterns available improves the design and also the building energy performance.





### Wellbeing and efficiency

Expanded mesh is a unique material that is both transparent and shading due to the characteristic 3-D shape.

This feature helps with the creation of innovative screening solutions to control the light during the day. The shade provided is greatest when the sun is at its highest. The frontal opening of the mesh maximizes the amount of incoming daylight leaving an open view to the outside world. This makes the rooms in the building bright and cool at the same time.

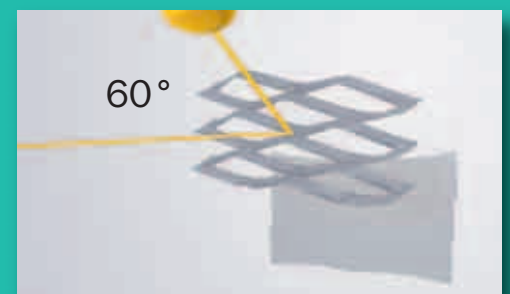
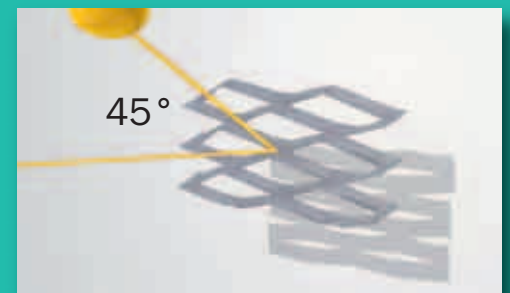
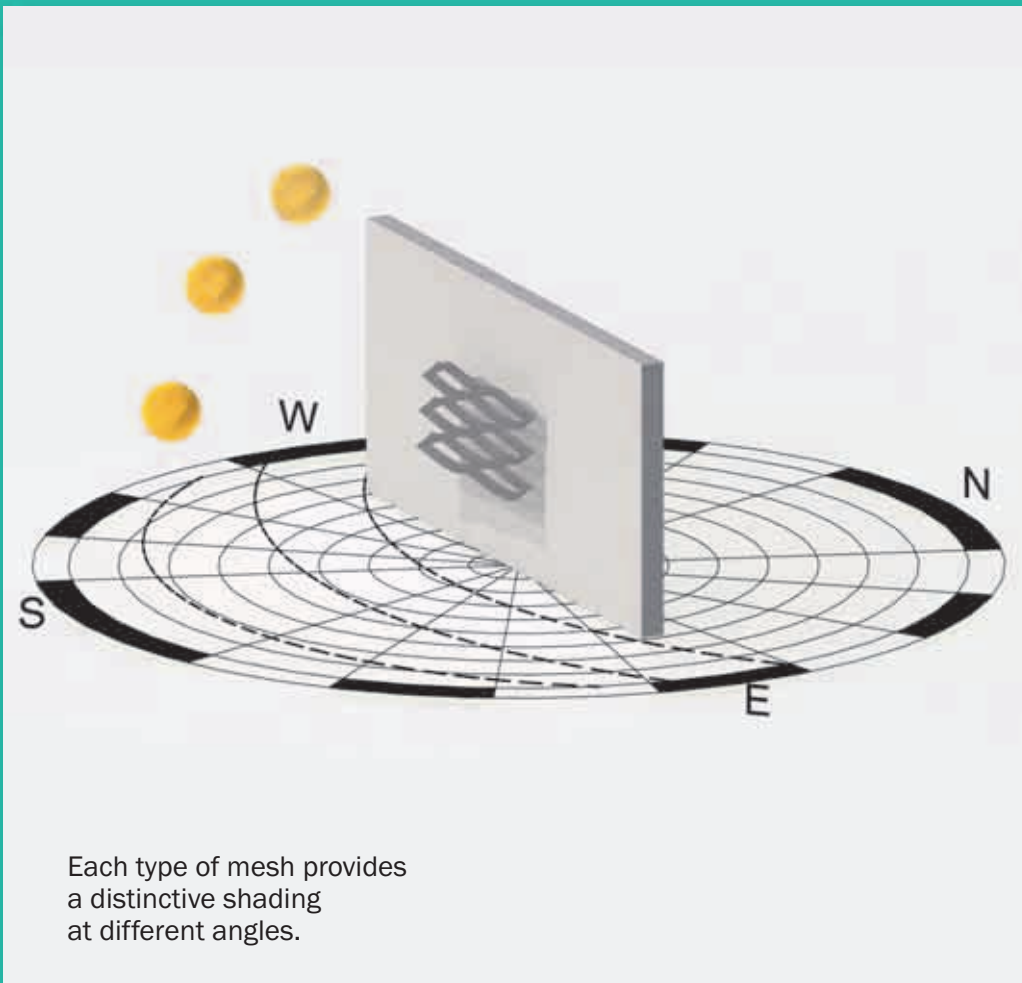

### The study of light through expanded mesh

Sunlight depends on the geographical position, the orientation of the façade, the season, and the time during the day.

## THE DESIGN REQUIREMENTS

PEOPLE'S WELLBEING AND ESPECIALLY THEIR SAFETY IS THE PRIMARY OBJECTIVE OF ARCHITECTURAL DESIGN THAT COMPLIES WITH ALL THE INDUSTRY REGULATIONS

### Safety

When the right fastening techniques are used, expanded metal panels are a safe solution in every type of use and application. This suspended parapet gives a sense of solid protection due to the sturdiness of the material.

Safe and practical solutions for:

- protecting people
- isolating hazards
- preventing risks



### Load-bearing capacity in compliance with standards

Load-bearing capacities for walkable surfaces are certified to the Technical Construction Standard NTC2008. Adequate protection is also provided for the respective stairs.

### Anti-slip grating

Grating guarantees excellent non-slip results documented by the certification tests specified by DIN 51130 Standard and have also a anti-panic function.



### Aesthetic finish and durability

Long experience with architects and architecture has helped Longhi Group develop anodizing, paint treatment, and coating solutions with exceptionally high aesthetic quality and practicality.

An infinite range of colours provides creative and decorative possibilities as well as protection of the material (aluminium or carbon steel) against corrosion.



## **Strength and durability**

The expanded metal used in the construction sector and architecture is dimensioned to resist loads such as wind or snow loads.

The open shape of expanded metal also makes it suitable for applications that require ventilation and air flow such as car parks, utility rooms and transit areas.





© Raffaele Cipolletta, courtesy Mario Bellini Architects

### **Vertical elevations**

Creativity, prestige, impact.  
The personal mark on a project is often given by the choice of a distinguishing cladding.  
The selection of projects presented here (from many in our history) clearly demonstrate this.  
Expanded mesh make buildings stand out in the landscape.  
Many leading architects trust Italfim's know-how.

## LOUVRE MUSEUM ISLAMIC ART DEPARTMENT - Paris (F)



Design: Mario Bellini and Rudy Ricciotti  
Photo: Albert Greenwood - Courtesy of the Louvre  
Expanded metal cladding: METALLTECH  
Mesh: MTC A91 - A95 - Patented

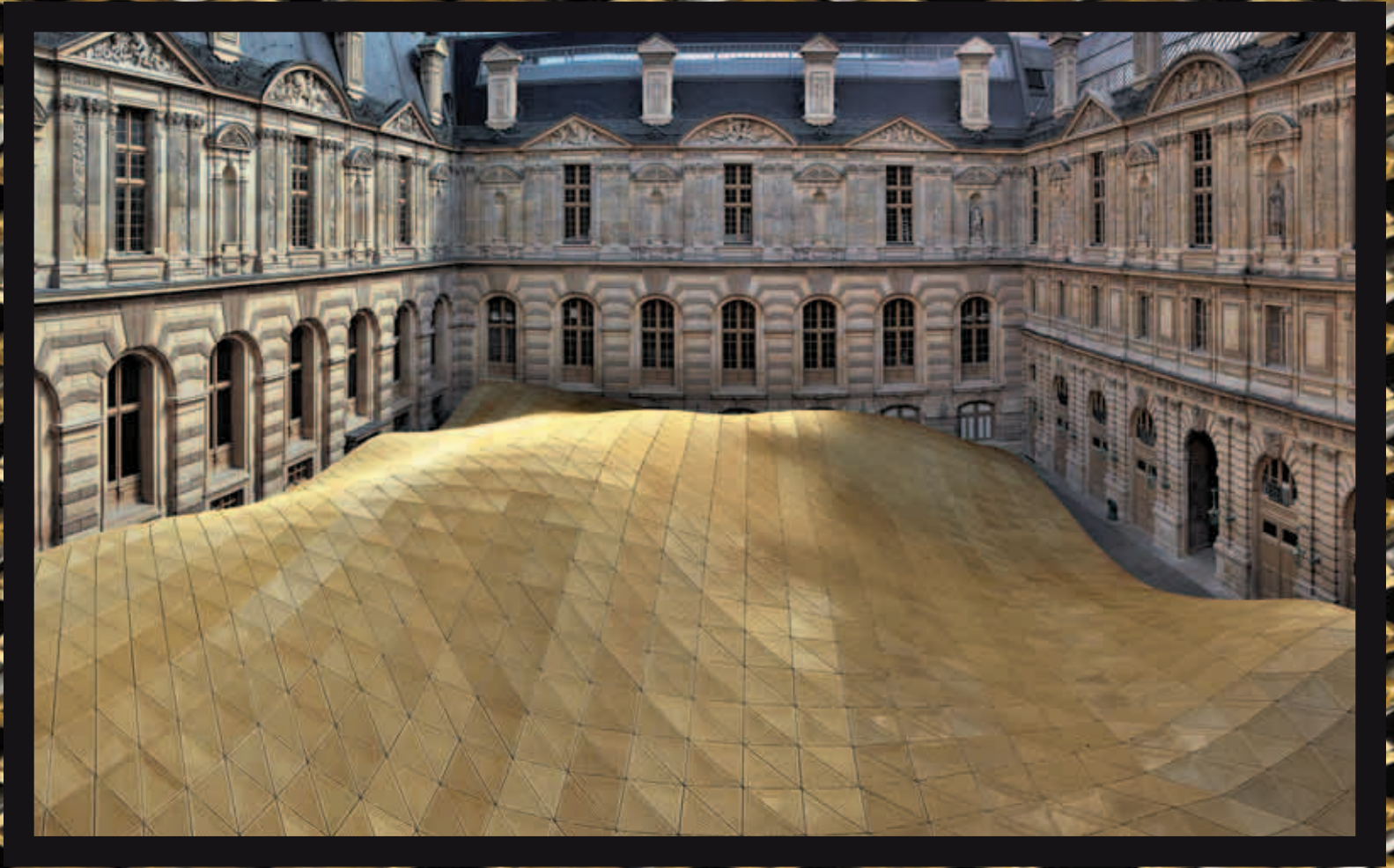

View of the impressive golden roof over the new Department of Islamic Art at the Louvre. Built using 4704 triangular expanded mesh panels it protects the museum's precious collection of Islamic art. This fluctuating, semi-transparent wavy surface was



designed to express the concept of co-existence between the distinctive forms of Islamic art and the Louvre's classical 18th century character. It is inspired by the chainmail armor of mediaeval knights.

# JANSEN CAMPUS OF INNOVATION AND TECHNOLOGY Oberriet (CH)



Design: Arch. Davide Macullo

Photo: Pino Musi



An angular external shape for the new building, reminiscent of a quartz crystal nestled amongst the breathtaking Alps landscape. Surrounded by nature, the large piazza and the wide window clearly define the purpose of the new Jansen Campus: an open space dedicated to communication, meetings and the exchange of creative ideas among professionals.

R 12.75 x 6 - 1.5 x 1 mm - Rheinzink®

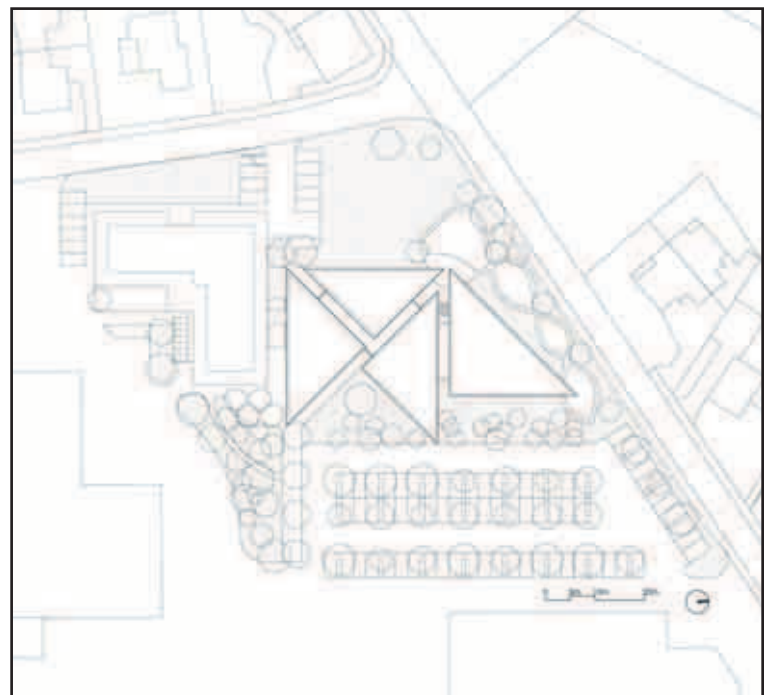
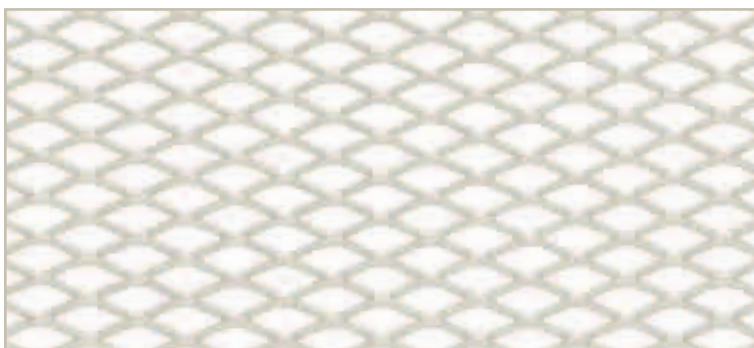



Oberriet, like a typically Swiss landscape, shows a multitude of sloping levels, each of a different size and at different angles and directions. The overhanging roofs are one of the main features of this new building, creating different shading effects and light reflexes throughout the day. Long vertical expanded mesh panels lay side-by-side to clad the building.

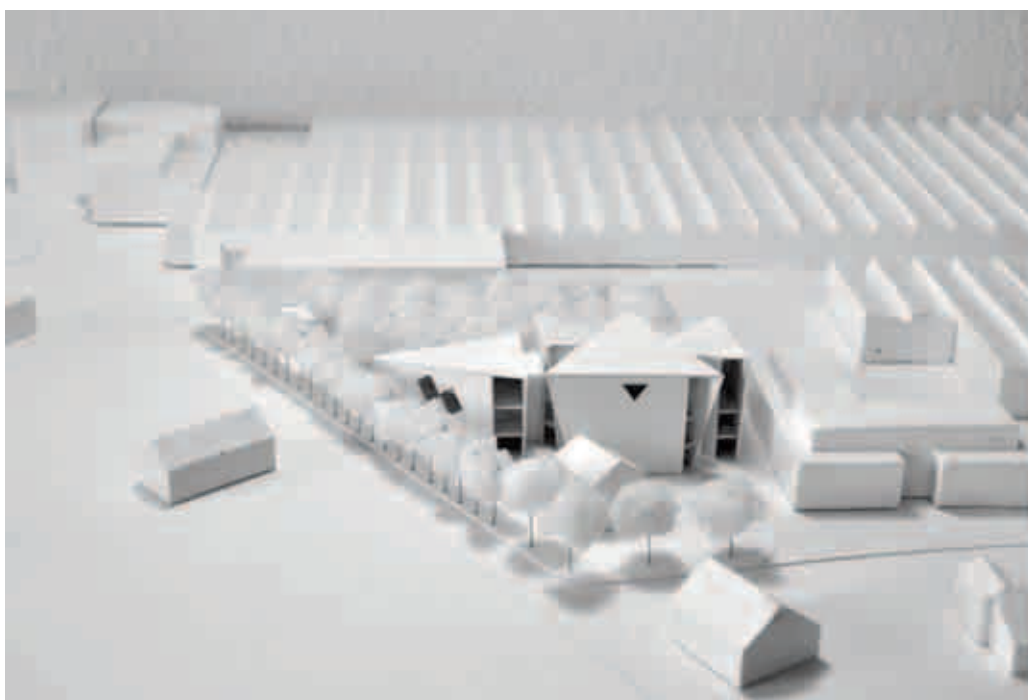

The building appears like wrapped in a fine 3D film, pierced by the large glazed windows over the park.



The expanded mesh is made from dark pre-partinated Rheinzink® titanium zinc. This special finish gives the material a colour in synphony with the local wooden buildings. Used for external cladding, it shines with different effects of shade and reflex though the day. The modular structure and dense elongated pattern add to the scale of the building and make the approach to the structure interesting and a pleasing experience for the visitors.

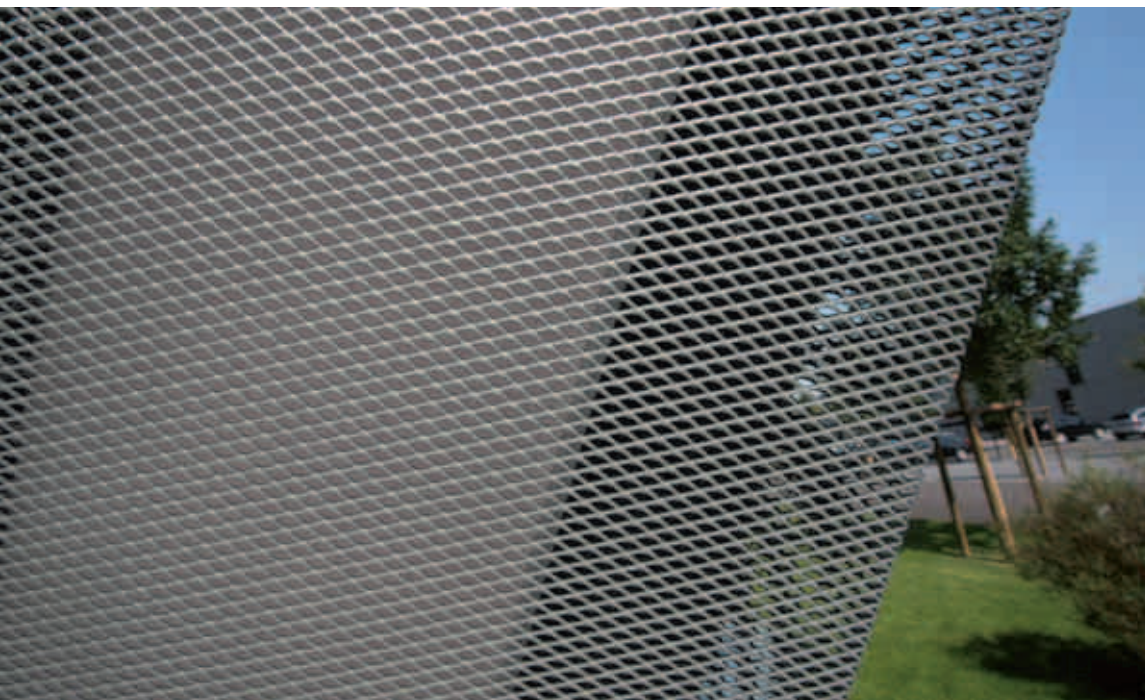

# TONI AREAL Zürich (CH)



Design: ARK - EM2N Architekten AG  
Photo: Huber Wettingen



A sequence of volume blocks to create the TONI AREAL complex in the heart of Zurich.  
Designed to host a university campus (arts, culture, dance and music), its external façades consist entirely of a combination of glass and pre-formed expanded mesh panels, creating a metallic intarsio effect.

**TAU 40** - T 20 - 3.25 x 2 - Ø 10 mm - Anodised aluminium

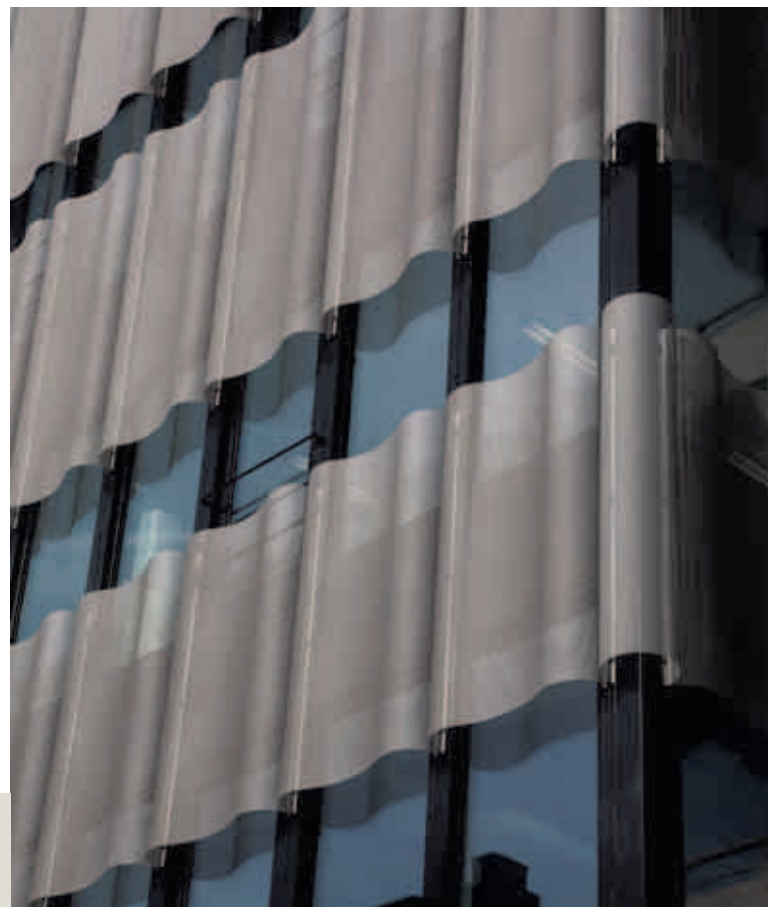





### **Brief history**

From 1974 to 2000, TONI was one of Europe's largest milk processing companies.

The production site in Zurich was equipped with highly advanced machinery for the receipt, storage, treatment and shipping of milk and dairy products, such as yoghurt, butter, cream, cheese, ice-cream and powdered milk.



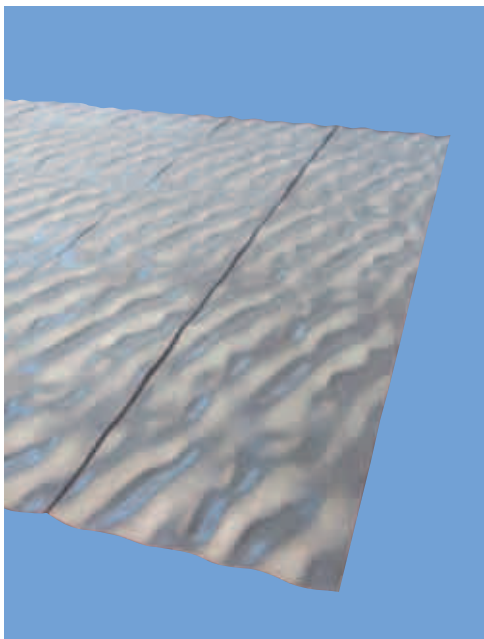

The wall panels facing the inner courtyards are made from pre-formed expanded mesh. These have been pressed in a special mould to create a "ripple effect". Panels are laid out side by side on the long side.

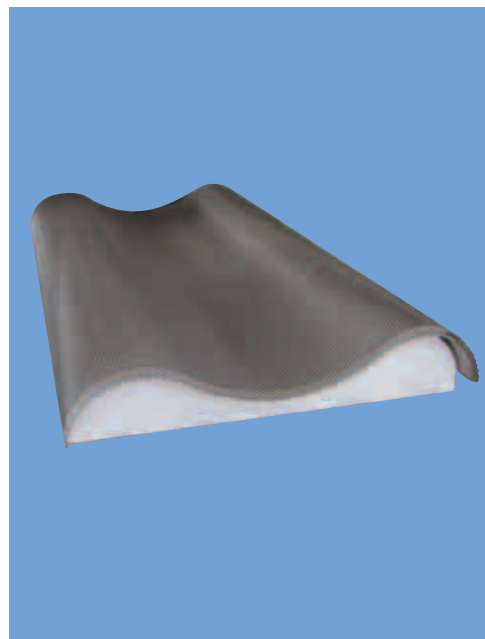

The external cladding panels are also made from corrugated mesh and they are controlled by using a template.



The expanded metal cladding symbolises the origins of this former industrial area, now a modern multi functional urban development. It combines areas dedicated to education and culture to those used for residential units and the local community, not to mention shops and parking areas.

**ST 10** x 7.0 - 1.6 x 2 - Ø 3.8 mm - Natural anodised aluminium

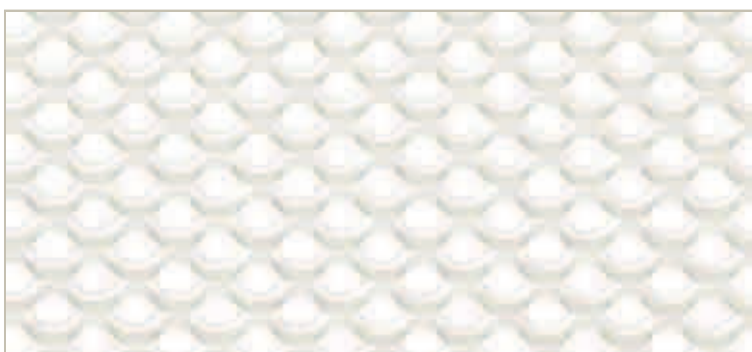

# THE CHURCH OF SAN GIOVANNI XXIII

## Seriate - Bergamo (I)



Design: Arch. Mario Botta

Photo: Studio Diecidodici



The inside cladding of the main entrance of this small, yet elegant church dedicated to Pope John XXIII is made from two close layers of expanded metal mesh that filter and break up the incoming light.

Double layer of round expanded mesh.  
Special pathways for the light are created by a careful superimposition of the mesh panels.

**ST 8** - 1.5 x 0.80 - Ø 3 mm - Powder coated pre-galvanized steel

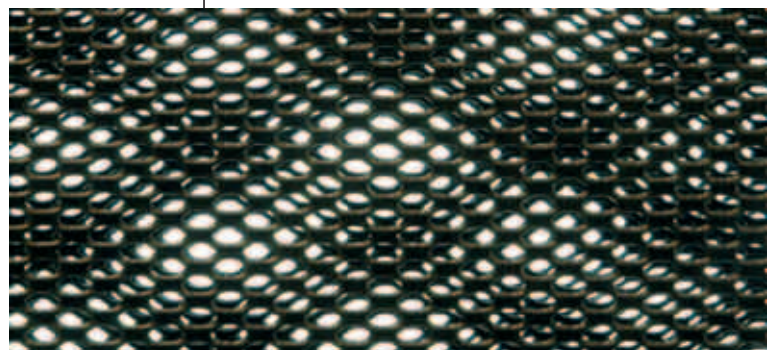





The "moiré" effect: the light flow is almost fluid, in perfect harmony with the spiritual context.

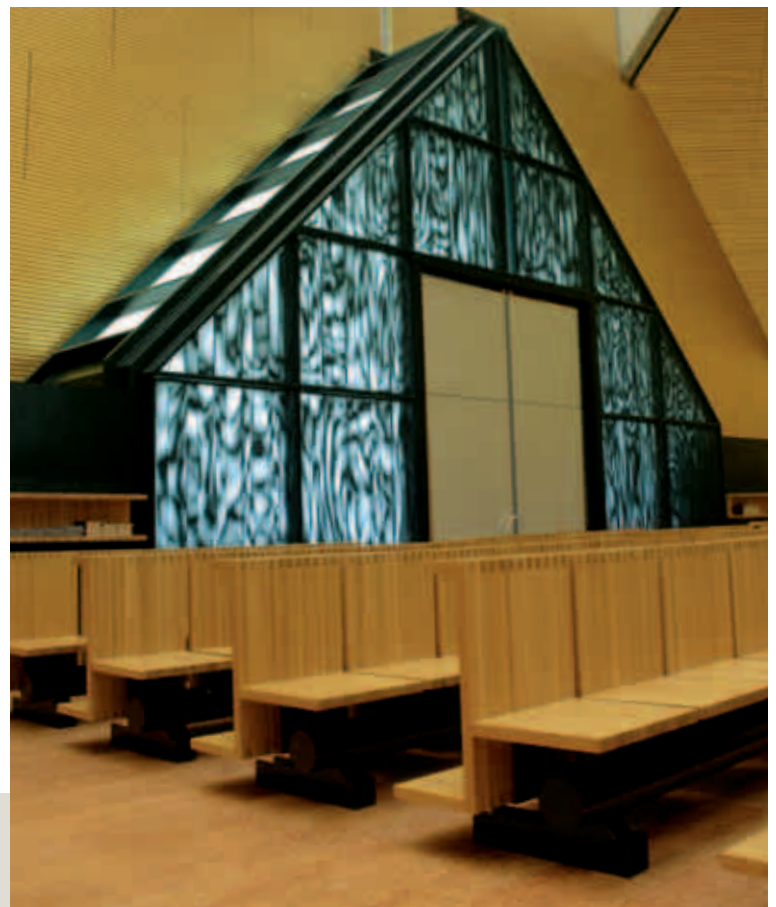
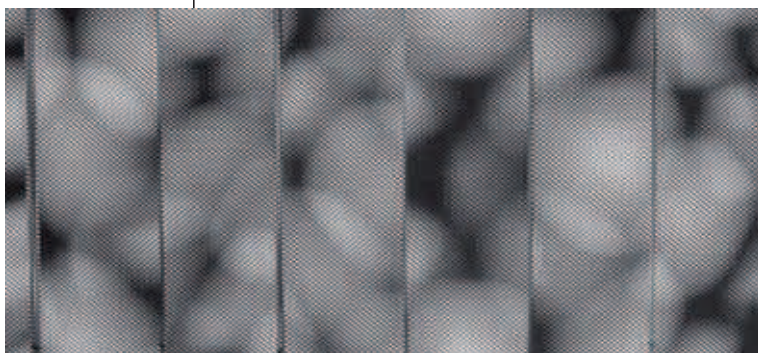

# HELSINKI ARENA EXTENSION

## Helsinki (FIN)

Design: ARK - House arkkitehdit oy - Arch. Pentti Kareoja  
Photo: Pentti Kareoja  
Expanded metal cladding: METALLTECH



Long decorative columns with a small radius curvature to enhance the long glazed façade.

**TAU 70** - T 40 - 6.5 x 2 - Ø 20 mm - Natural anodised aluminium

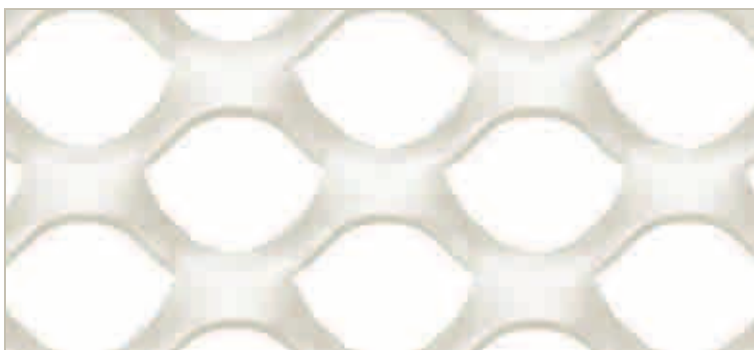

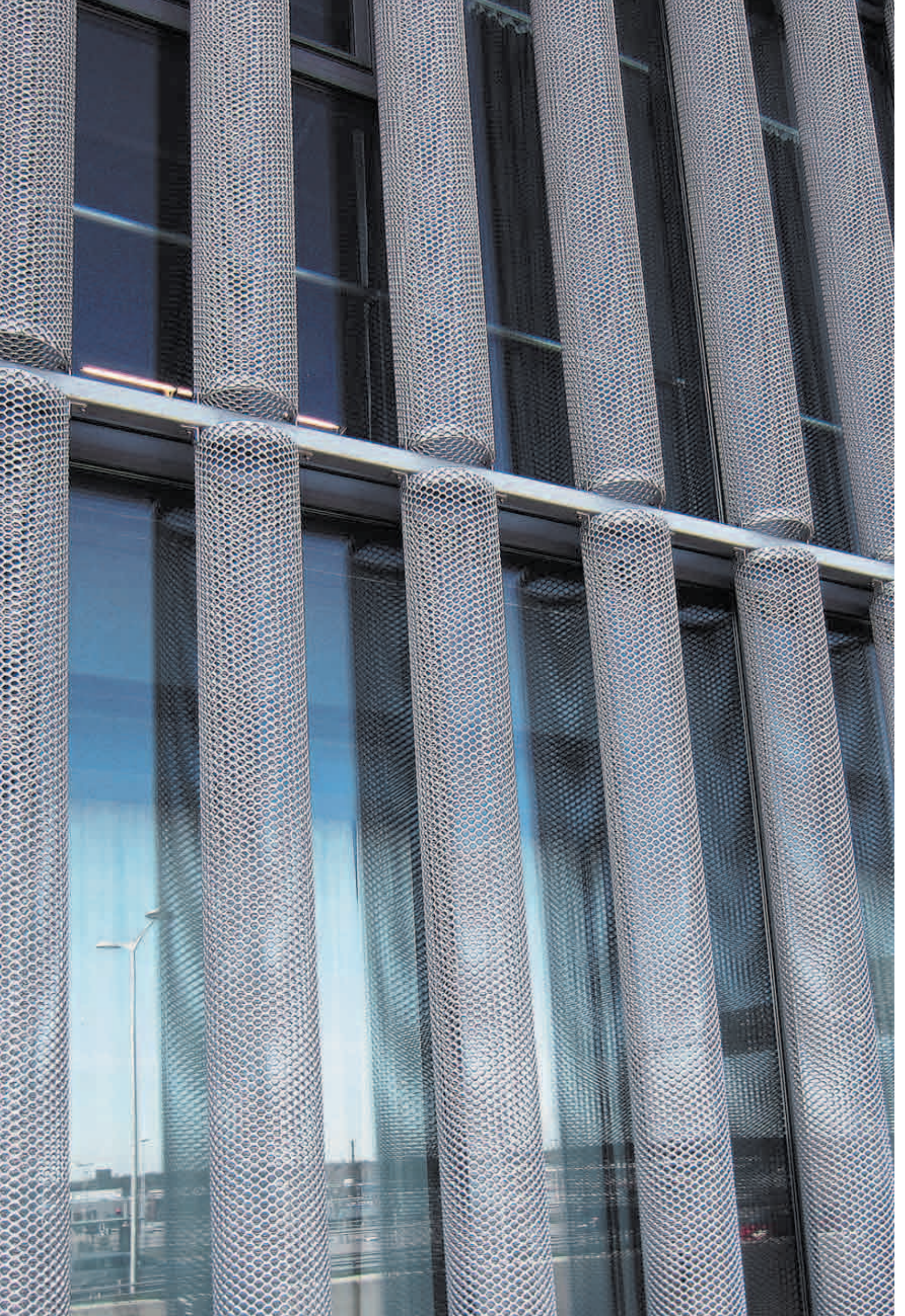

# WASTE HEAT VALORISATION PLANT Bolzano (I)



Design: Claudio Lucchin - Associated Architects  
Photo: Claudio Lucchin



The plant refurbishment included the addition of a soft green “sail” at the front, to harmonize the industrial site with the landscape. The expanded mesh is supported by a reticular self-bearing substructure.

**RB 75** - R 85 x 35 - 11 x 2 mm - Powder coated aluminium



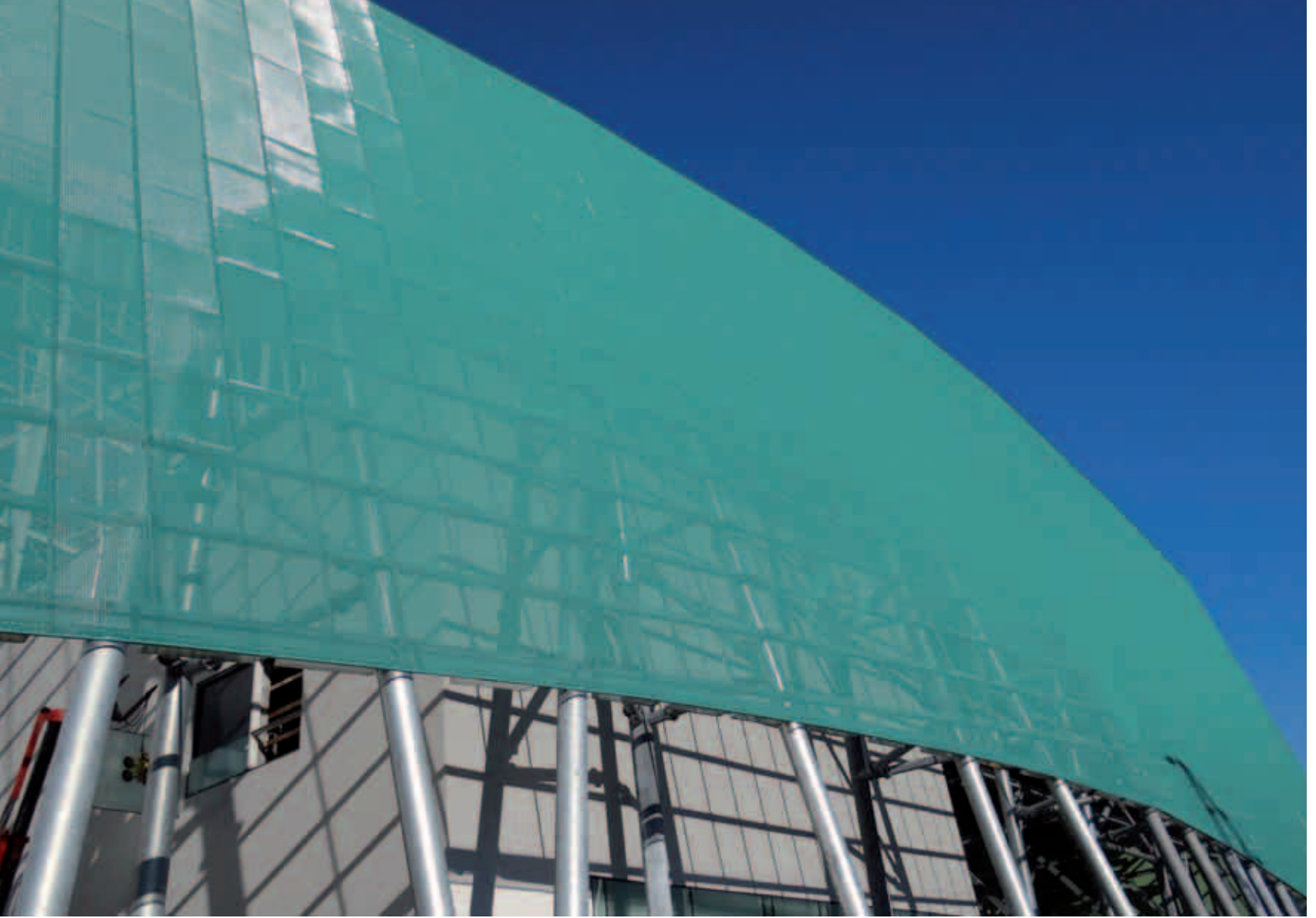

The curvilinear access points have been created by making the sheets of expanded mesh to size.

# CROWNE PLAZA - VERONAFORUM Verona (I)



Design: Arch. Mario Bellini  
Photo: Studio Diecidodici



Crystals have inspired the sloping shapes of the external cladding, “lightened up” by a cover of transparent expanded mesh.

**R 43-AS** - R 43 x 17 - 3 x 3 mm - Natural anodised aluminium

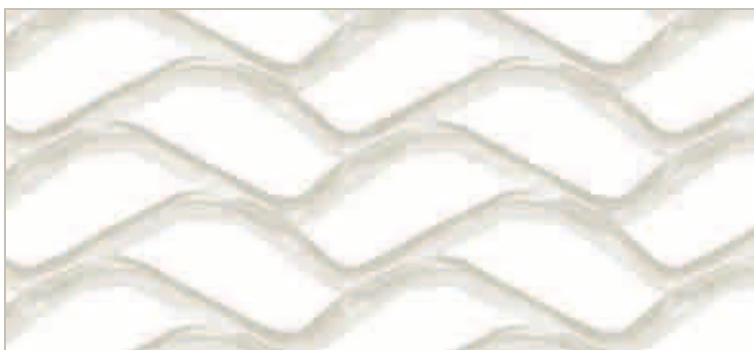



The large façades are decorated with "birds and clouds shaped rips" in the expanded mesh.

# GH GENHELIX BIOPHARMACEUTICAL FACILITIES León (E)



Design: Esaú Acosta, Mauro Gil-Fournier, Miguel Jaenicke, estudiosic  
Photo: Esaú Acosta



White circular columns made from expanded mesh are the main feature of the exterior of the building. Standing above the street level, they withstand the name of the company. The interiors and exterior produce a clean atmosphere perfectly associated to the image of this biotech company.

**TAU 50** - T 25 - 4.5 x 1.5 - Ø 13 mm - Powder coated hot dip galvanized steel

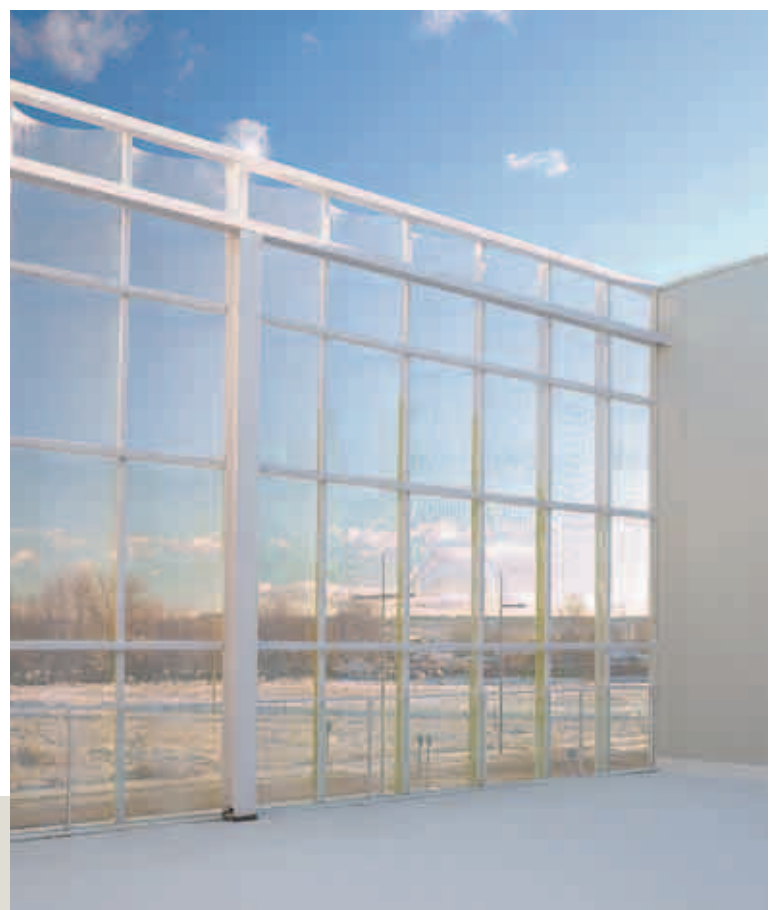





The transparency of the mesh helps those inside get a clear view of the surrounding area whilst exposed to the natural light for their wellbeing.

# LAFER BRENDOLA COMPANY HEAD OFFICE - Vicenza (I)



Design: Arch. Roberto Persello and Turrina  
Photo: Roberto Persello



This fluid and dynamic stage setting was created using expanded mesh panels in a restructuring project that enhanced the office block and harmonized the entire site.

**TERRACE** - R 43 x 18 - 8 x 1.5 mm - Powder coated aluminium

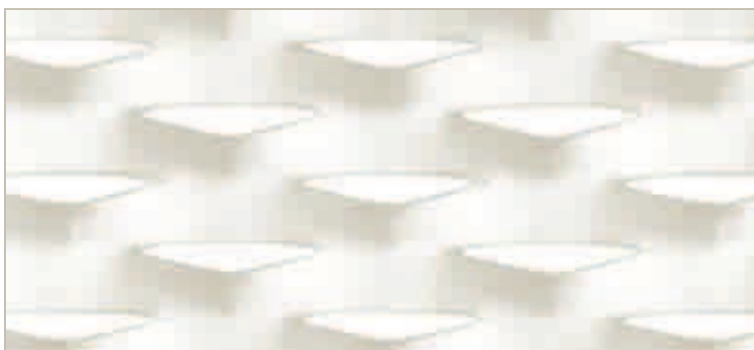

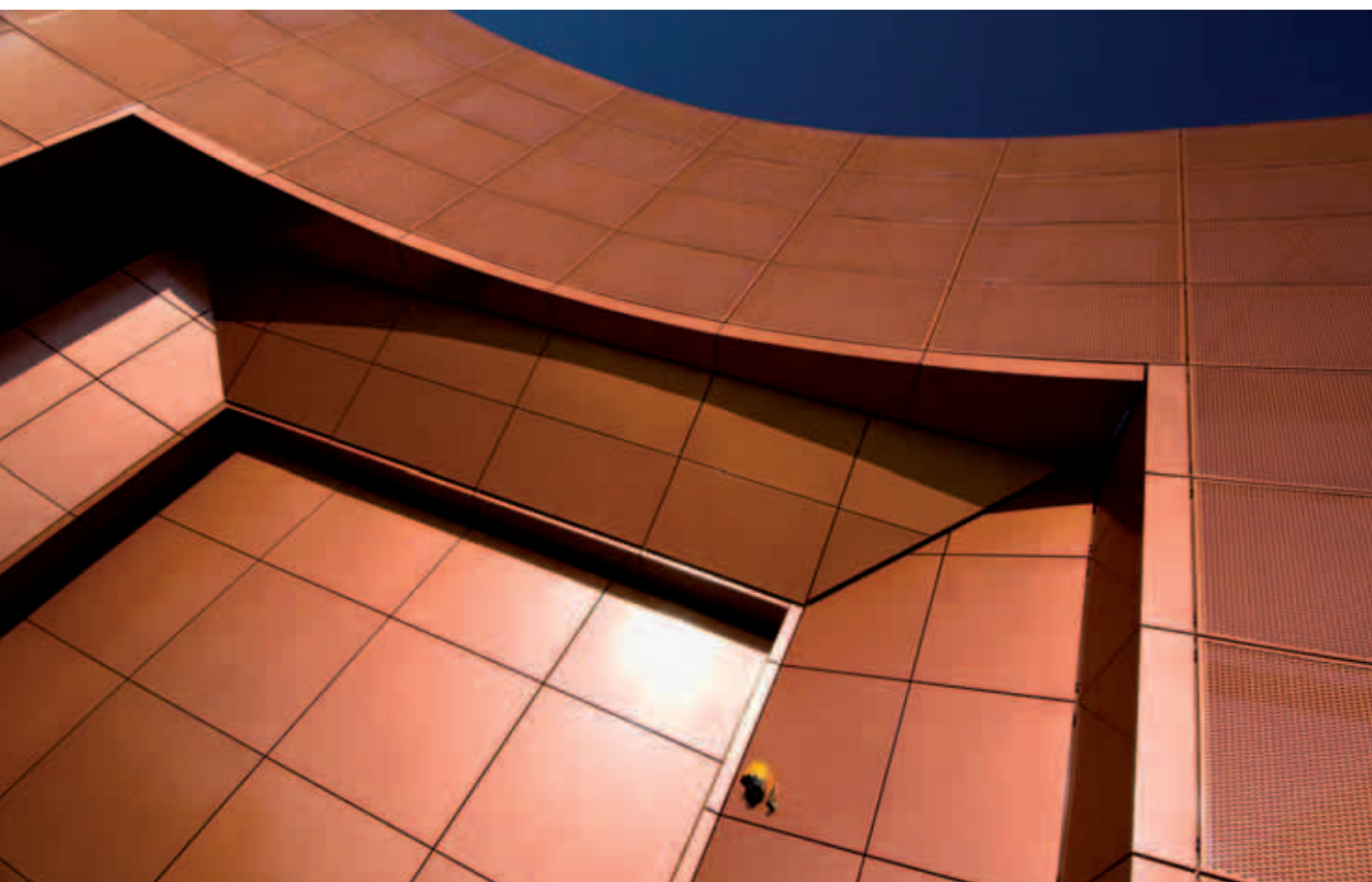

Detailed elevation showing the joints between the two wings of the cladding.

# PSENNER DISTILLERY

## Termeno Sulla Strada Del Vino Bolzano (I)

Design: Arch. Freissinger - Elzenbaumer  
Photo: Daniele Domenicali



A few round insets have been added to the expanded mesh cladding of the production plant, reminiscent of the “bubbles” of steam seen in distilleries. The night lighting has been enhanced by fitting the expanded mesh “upside-down” so that the apertures face upwards. This creates a pleasing white light effect.

**Exa 16** - E 80 x 30 - 13 x 1.2 mm - Zinc-titanium zintek® rolled steel

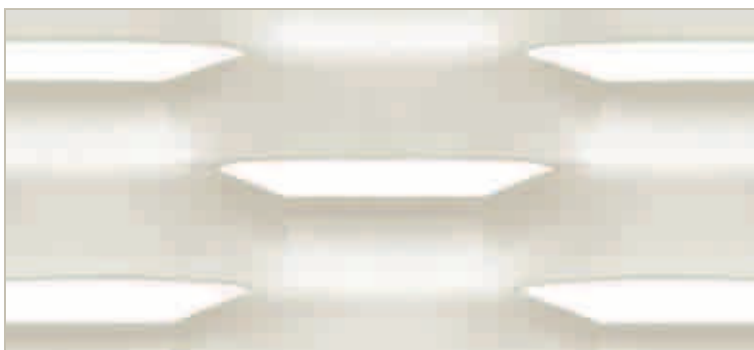



# SHOPPING MALL Napoli (I)



Design: Arch. Pica Ciamarra Associati  
Photo: Arch. Pica Ciamarra



Framed panels have been used to clad the main building and protect the stairs of this shopping mall near Naples. For a transparent metal shell effect.

**Deco 91** - E 45 x 8 - 3 x 1.5 mm - Natural aluminium

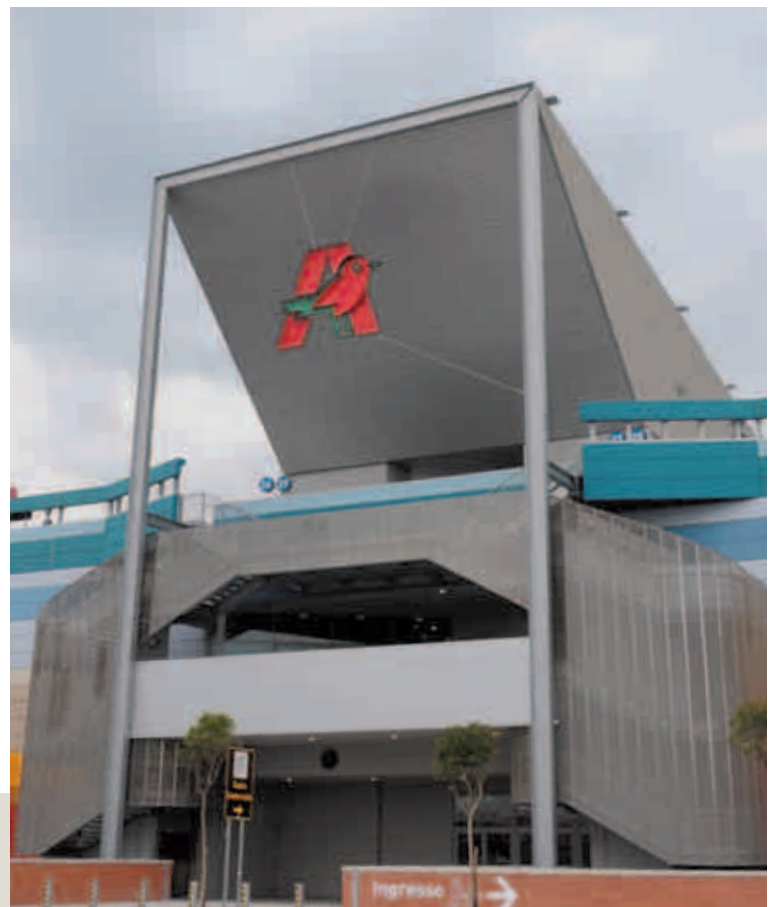



A smooth front disguises  
and protects the plant.  
The expanded mesh gives  
a uniform look to the complex.

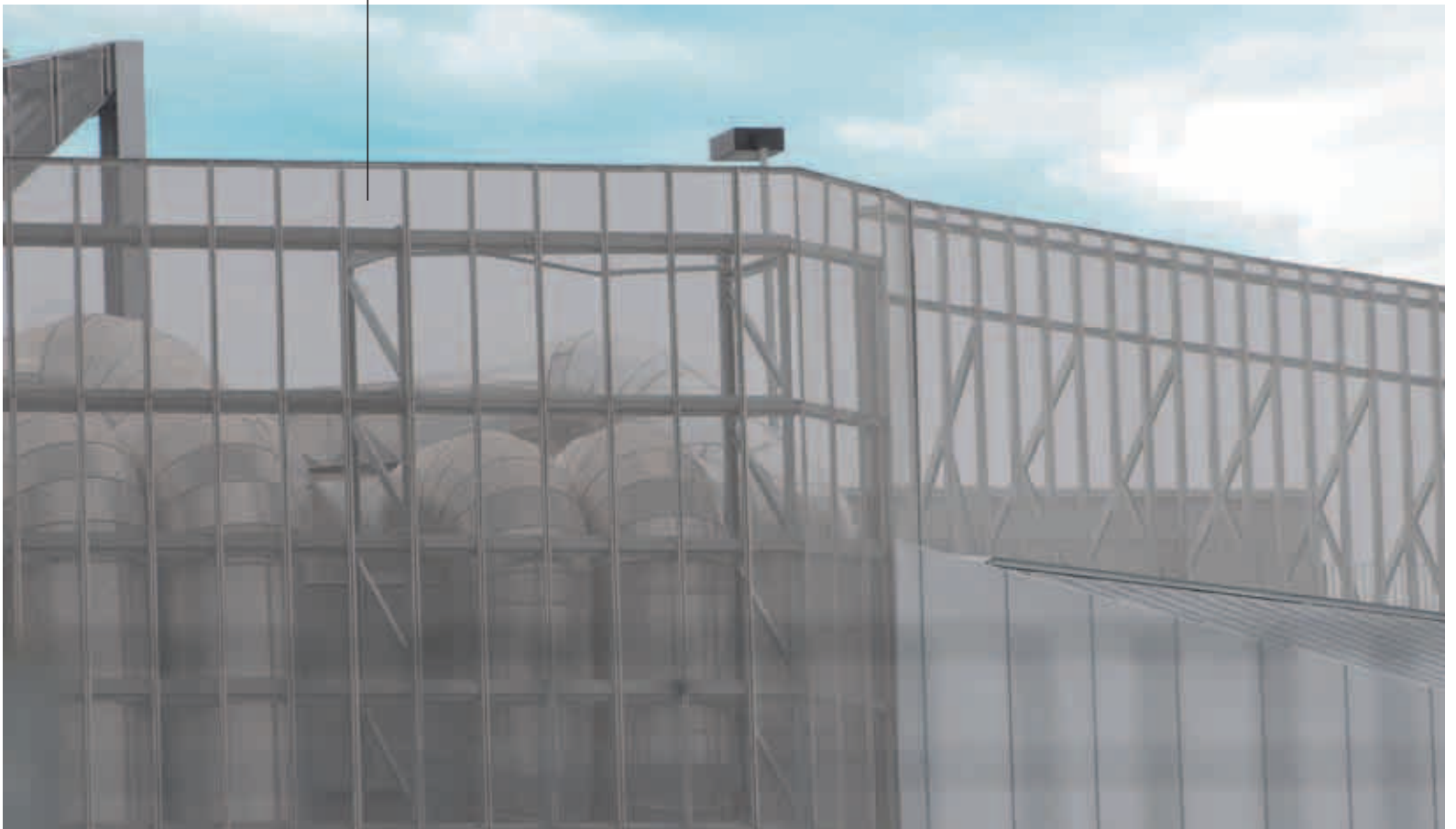

# COVERS FOR THE MESTRE MOTORWAY TOLL GATES Venezia (I)



Design: Arch.Tommaso Michieli - Arch.Christian Zanatta  
Photo: michielizanatta



Front view of the toll gates at the Mestre motorway exit with high “fin shaped” structures cladded with expanded metal mesh. The suspended ceiling, also made from micro-expanded mesh, hide perfectly any service cables.

Detail of the pillar protection: an architectural feature, its “outline” seemingly shaped by the wind. The metal surface creates an iridescent effect when lit up at night.



**Q 30** - 23 - 2 x 2 mm - Powder coated aluminium

**Gate** - R 76 x 31 (35) - 11 x 1.5 mm - Powder coated AL.

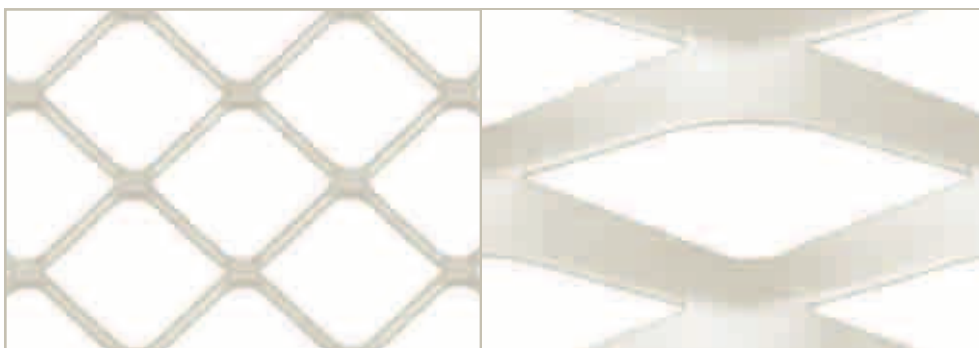





# FASTWEB HEAD OFFICE Milano (I)



Design: Studio Starching srl - Milan

Photo: Studio Diecidodici



The cladding of the stairs together with the glass smooth materials used for the façade create an eclectic yet functional design. The expanded mesh panels hooked onto the pre-existing substructure.

**ST 30** - 6 x 2 - Ø 15 mm - Powder coated aluminium



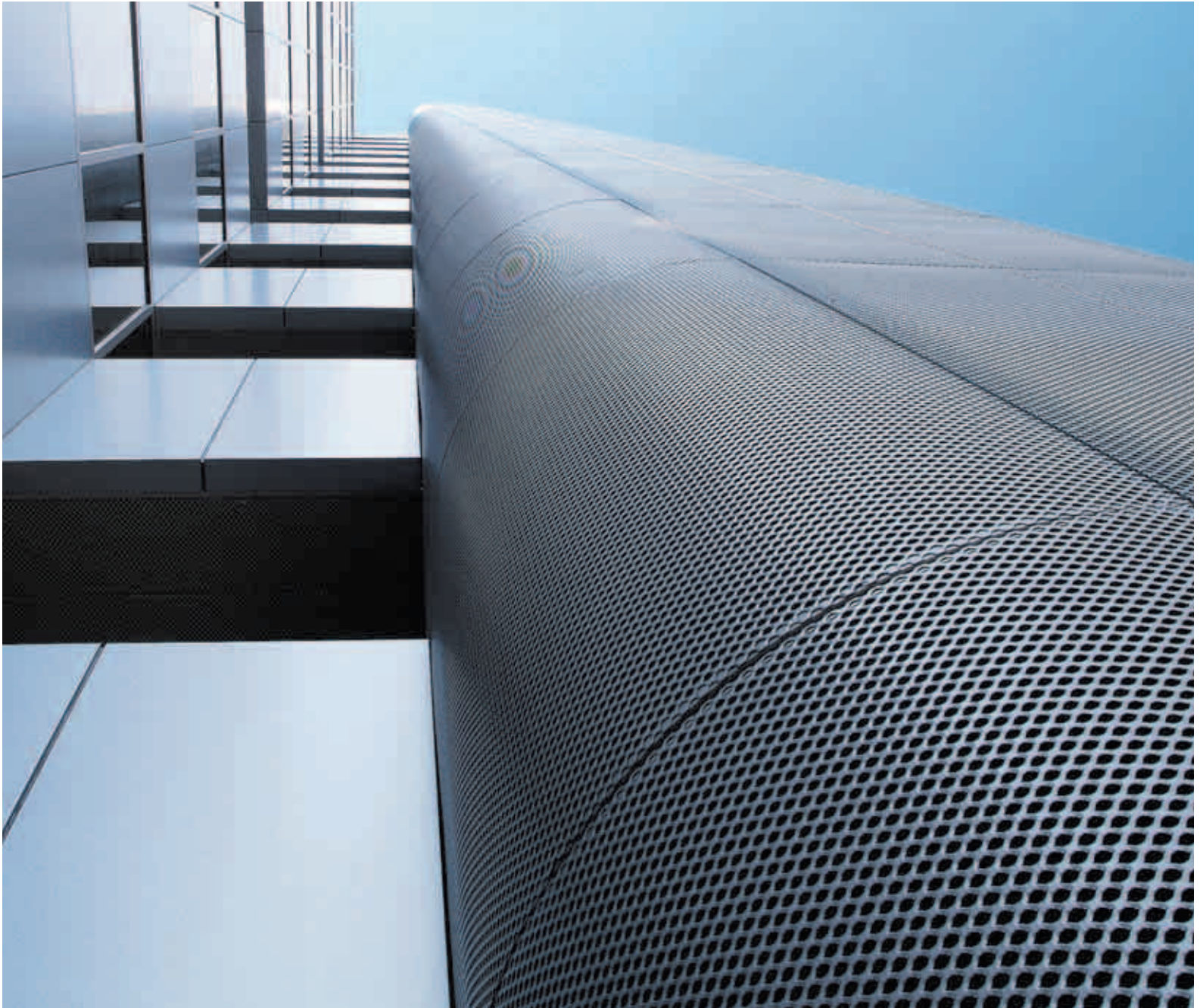

Expanded mesh  
suspended ceiling.

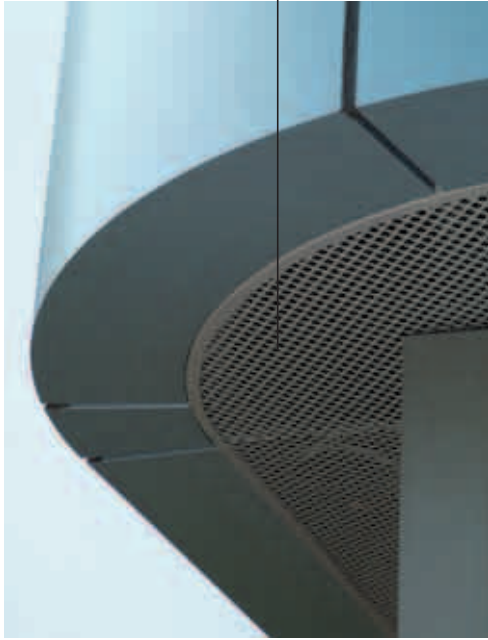

Light points in the  
suspended ceiling.

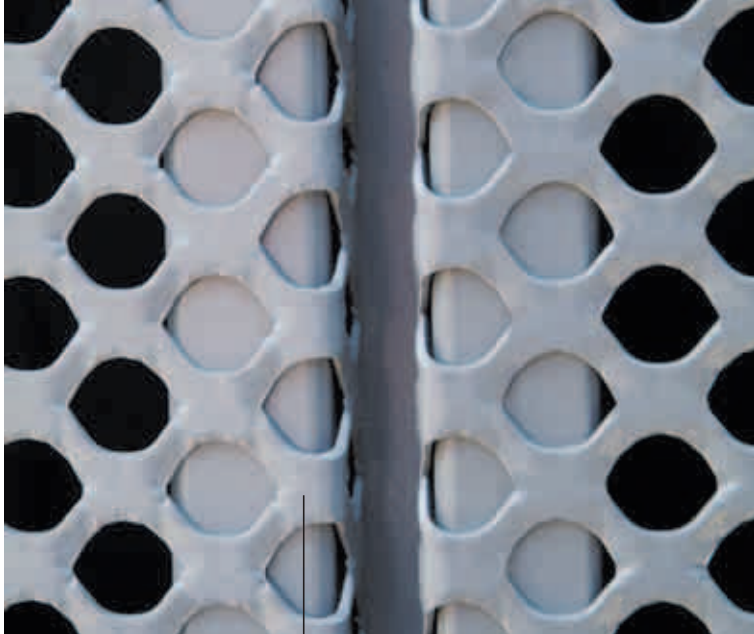
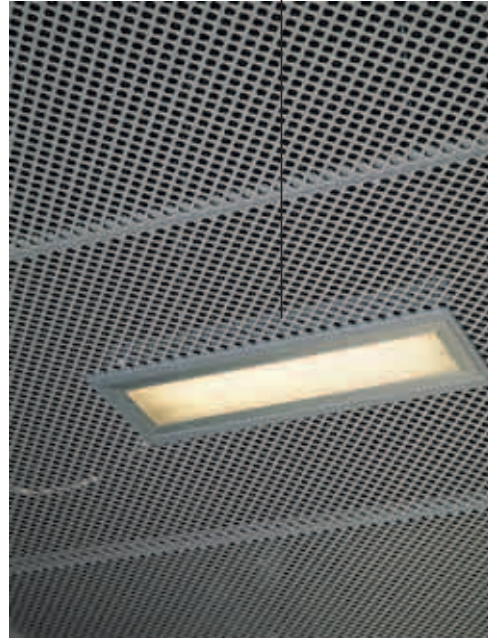

Detail of the fixing to the existing  
sub-structure and gap between the panels.

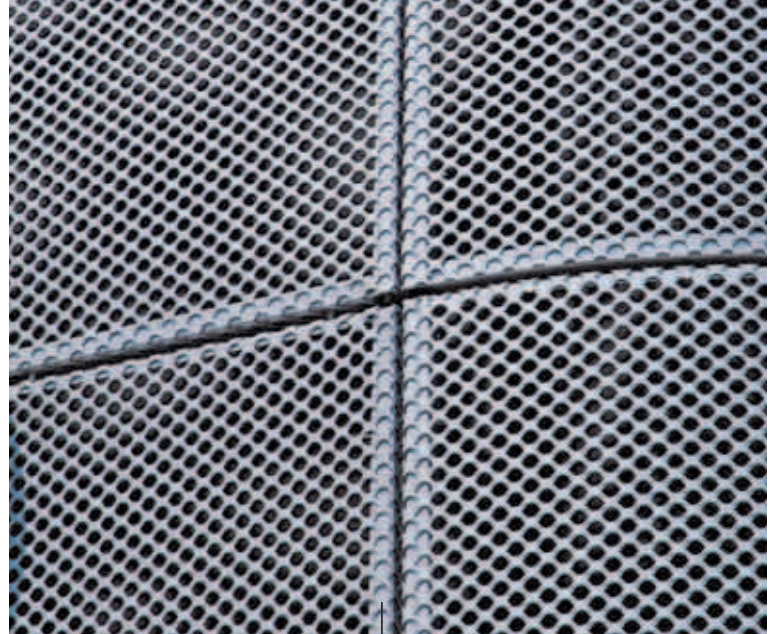

Detail of the modular  
composition.



# TECHNICAL AND REMOTE HEATING PLANT SAN RAFFAELE HOSPITAL Milano (I)



Design: Cooperativa CIMAS - BS

Photo: Studio Diecidodici



The area housing the service equipment for the hospital has been completely cladded and protected using strong expanded mesh panels also providing the necessary ventilation throughout.

**Country** - R 100 x 30 - 11 x 1.5 mm - Powder coated aluminium





Detail of the junction  
between the open  
expanded metal and  
the solid metal.

# STOPPANI HEAD OFFICE Neuenegg (CH)



Design: Burckhardt Partner AG  
Photo: André Huber



Simplicity and transparency are the key architectural features of this building. The large glass façades are shaded by a skin made from expanded mesh elements. At night the building “sparkles” with light.

**ST 8** - 1.5 x 1.5 - Ø 3 mm - Powder coated aluminium







# SHOPPING CENTER Milano (I)



Design: Guidarini Salvadeo, Architetti Associati  
Photo: Studio Diecidodici



The light corrugated panels follow the profile of the façade, protecting the glass and enhancing the transparency effect.

**ST 10** - 1.6 x 1 - Ø 5 mm (corrugated) - Natural anodised aluminium

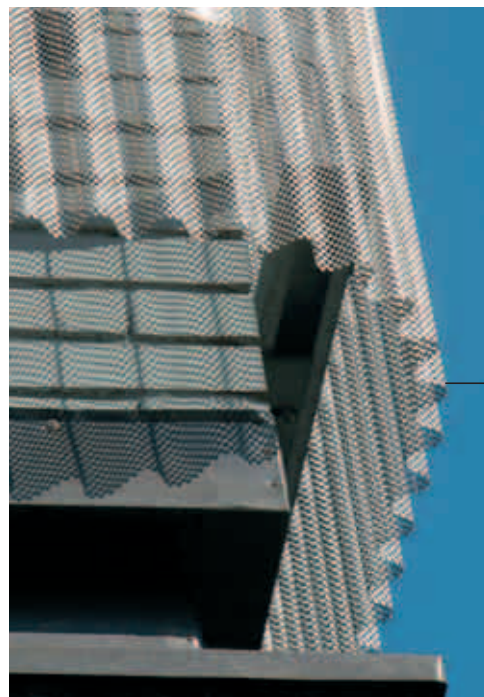
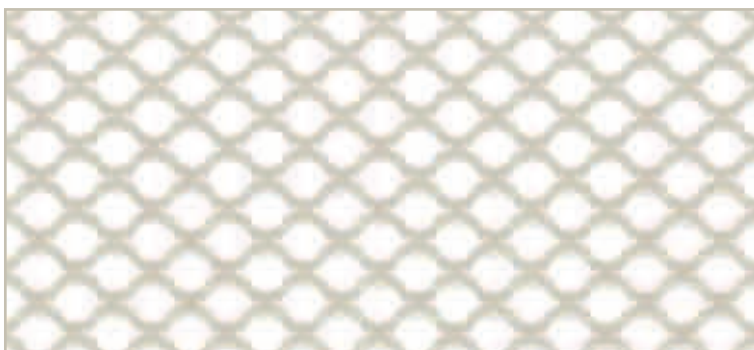

Details of the shape of the joint at the corner of the building.

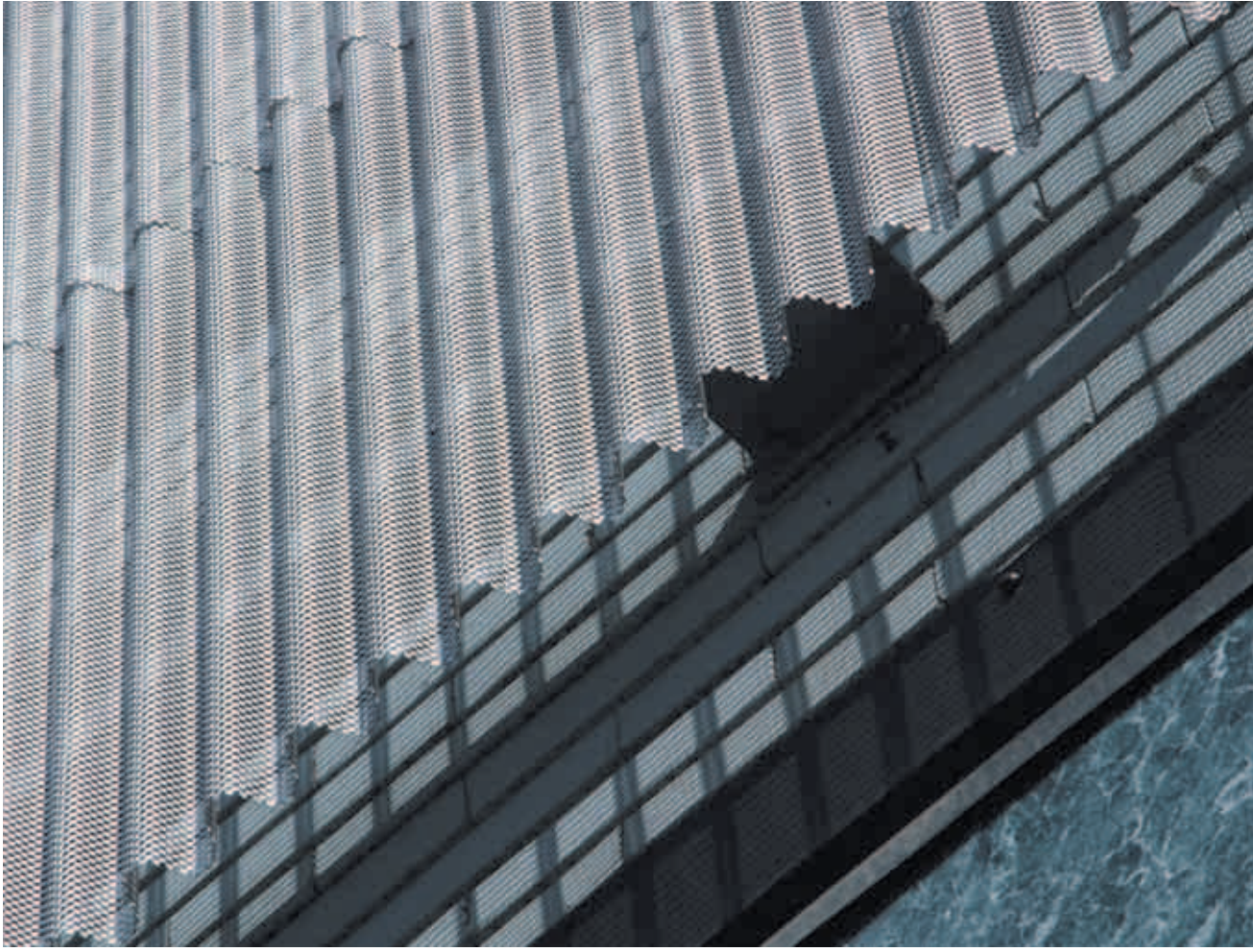

# HOTEL RAMADA PLAZA Milano (I)



Design: Boschi/Serboli Associates Architects - Architect Arrigo Taini  
Photo: Studio Diecidodici

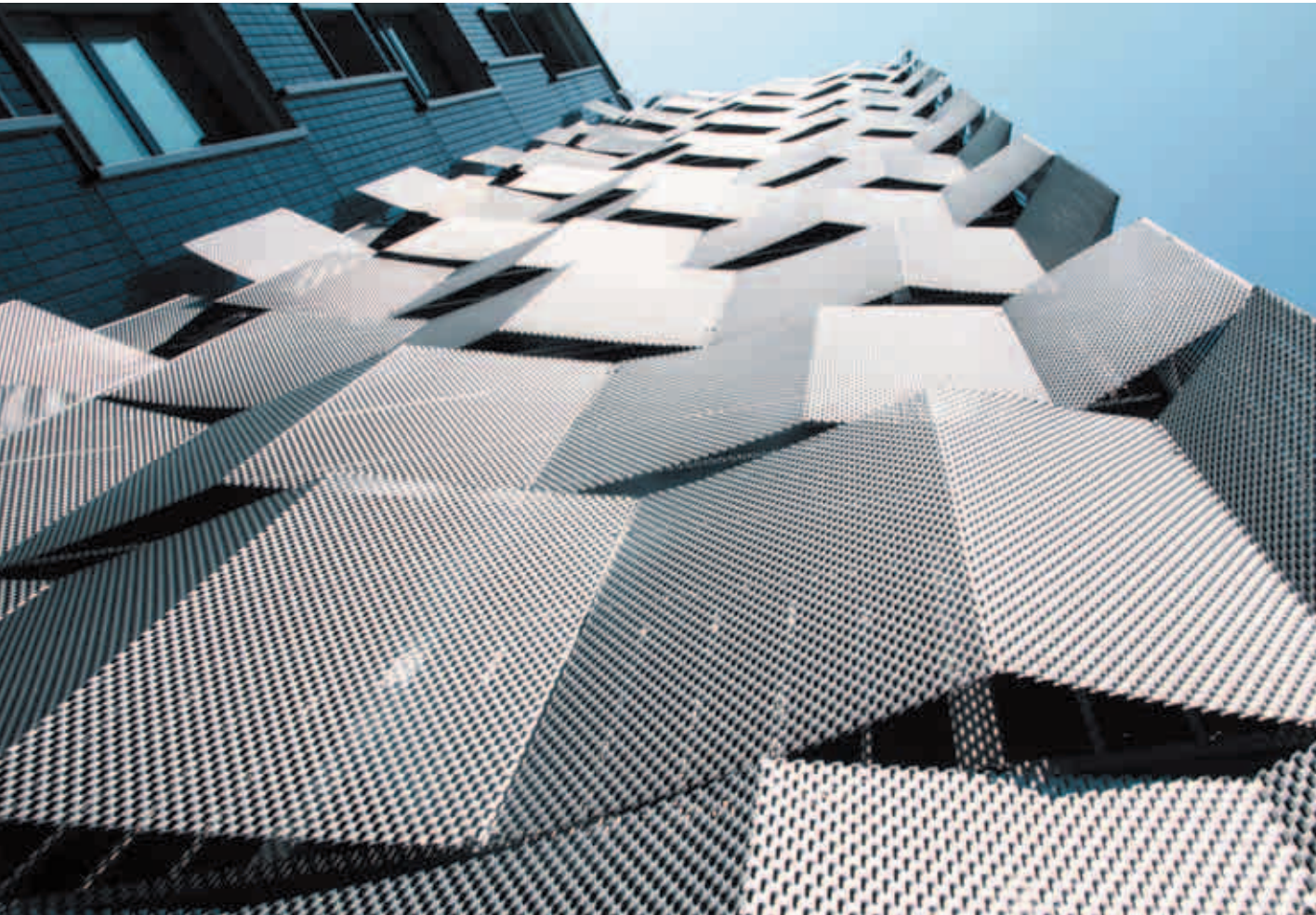

Folded expanded mesh panels have been used to clad the stairwell in this multi-purpose building. The panels dynamically create light and shade effects that continually change during the day as the sun moves in the sky.

**E 45** - E 45 x 16 - 6.5 x 1.5 mm - Natural anodised aluminium

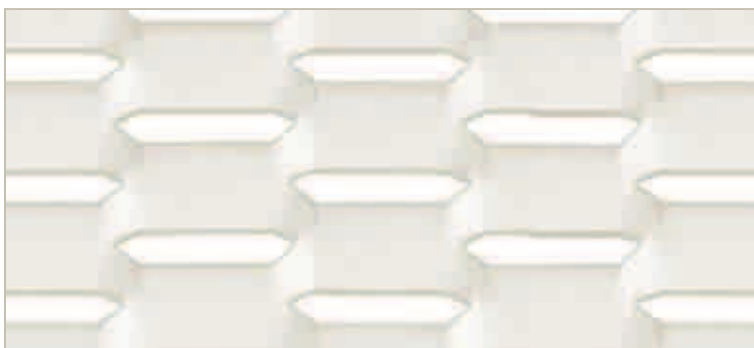

The mesh panels are installed at different angles and staggered.

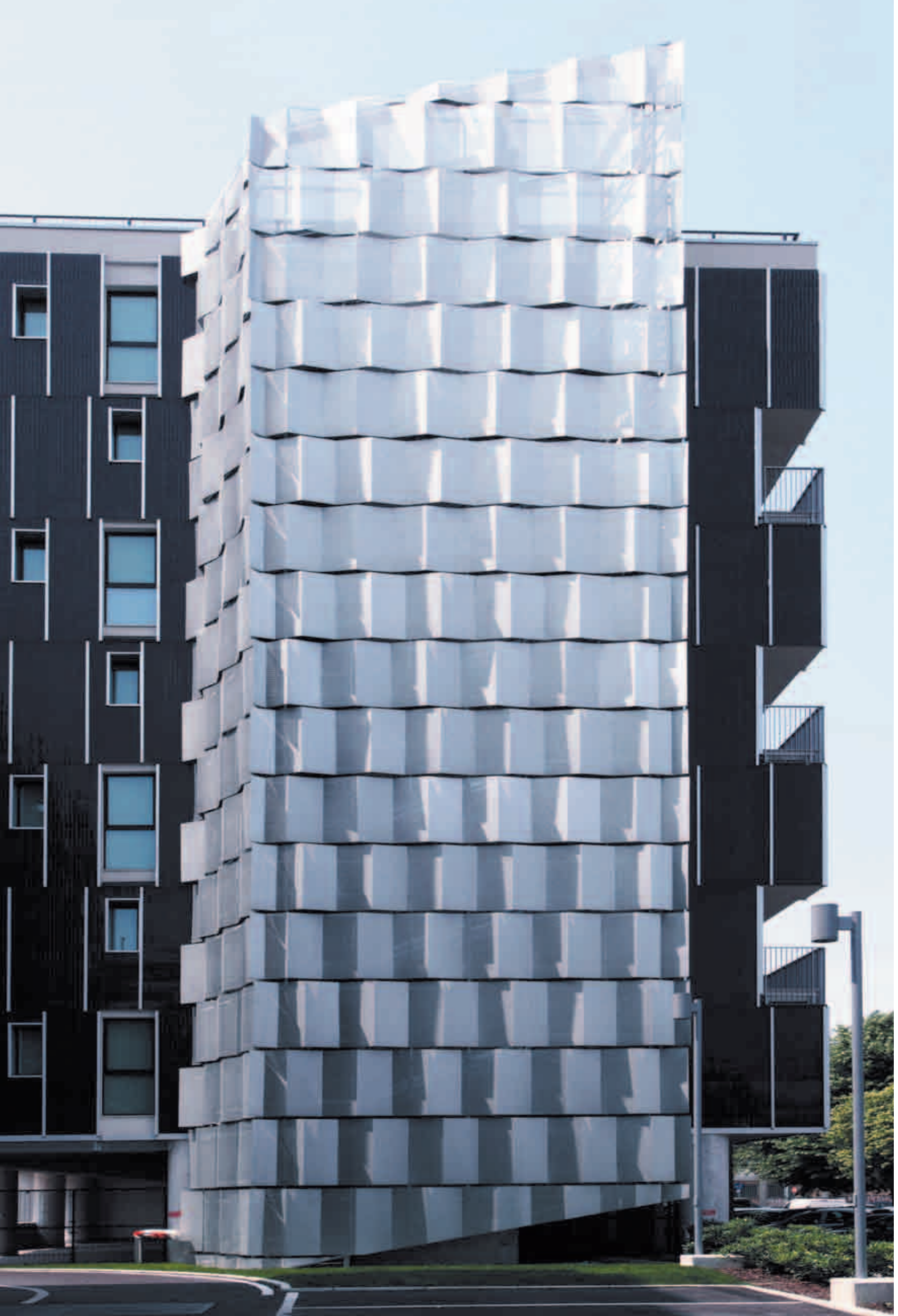

# MONTE DUE MANI MULTI-PURPOSE CENTRE Ballabio - Lecco (I)

Design: Arch. Augusto Colombo - Marcello Tommasi  
Massimiliano Agostoni - Andrea Mattioli  
Photo: Chiara Aldeghi



Views of the modern structure with various recreational spaces. The exterior walls are made from Corten steel expanded metal mesh, a design that represents the close link of this geographical area with the metalwork industry.

**Residence** - R 45 x 18 - 8 x 1.5 mm - Corten



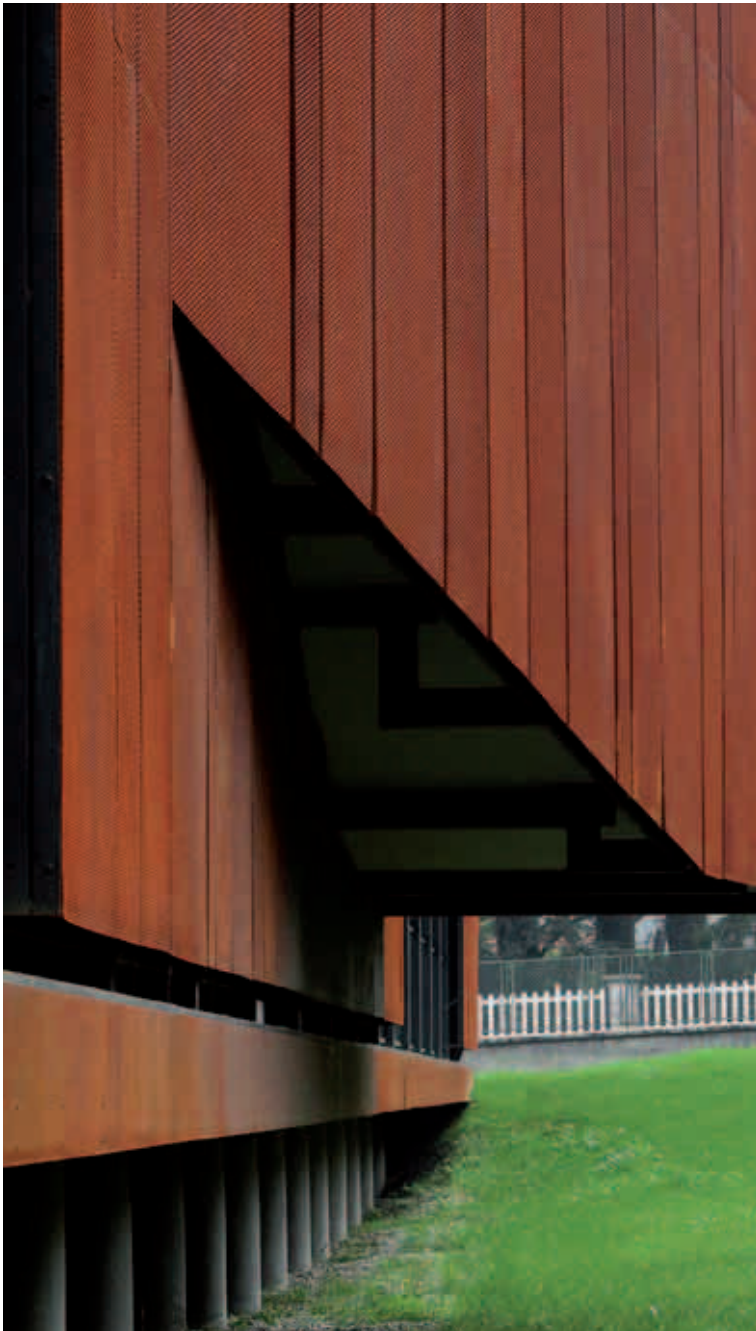

Corten steel has a natural colour and a variable shade that eventually stabilise. The choice of material made the building a good fit with the surrounding landscape.

# CAMERINO UNIVERSITY Macerata (I)



Design: PENSY  
Photo: PENSY Archives  
Expanded metal cladding: METALLTECH



Based on various shades of green, the expanded mesh façade has given the Mathematics Faculty a face-lift improving, at the same time energy efficiency by means of different degrees of shading.

**Exa 16** - E 80 x 30 - 13 x 2 mm - Powder coated AL.

**Exa 05** - E 50 x 23 - 8 x 2 mm - Powder coated AL.

**RB 65** - R 62 x 23 - 8 x 2 mm - Powder coated AL.







The expanded mesh panels have changed the profile of the building, with open gaps for the pre-existing windows.



Panels folded on all 4 sides, with combinations of different mesh patterns and open areas for a unique result.



The expanded mesh cladding has a dual function: it protects the insulation layer from temperature spikes and it also improves the look of the building.

# MESSE GRAZ

## Graz (A)



Design: Riegler Riewe Architekten zt  
Photo: Jürgen Eheim



Ultra-light expanded mesh steel elements for the "HALL A" pavilion at the Graz Exhibition Centre, a major trade fair venue.

R 20 - R 20 x 7.5 - 1.5 x 1.5 mm - AISI 304 stainless steel, powder coated

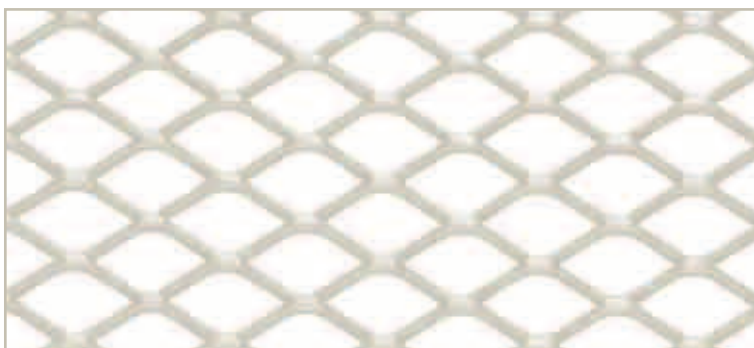

Stamped diagonal rib with a geometric bas-relief effect.

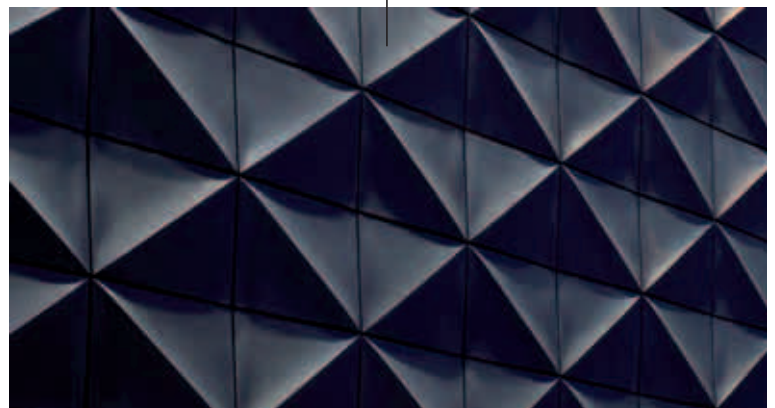



# CONSTRUCTION COMPANY

## Milano (I)



Design: Arch. Riccardo Blumer  
Photo: Studio Diecidodici



The dynamic effect of the strips of expanded mesh hung from above and then anchored and twisted by hooks at the bottom. The torsion effect of the cladding improves the shading and re-invents the building.

**RB 65** - R 62 x 23 - 8 x 0.6 mm - Stainless Steel AISI 304





Anchoring of the strip at the bottom.

# MULTI-STOREY CAR-PARK Bergamo (I)



Design: Ufficio Tecnico Comune di Bergamo  
Photo: ITALFIM Archives



The car-park next to the Bus Station has an outer wall made from modular framed panels. Two horizontal rows: grey mesh at the bottom and red mesh at the top. The mesh protects the car-park and provides the requested air flow.

**TAU 40** - T 20 - 3.25 x 1.5 - Ø 10 mm  
Powder coated steel

**Exa 04** - E 40 x 20 - 7 x 1.5 mm  
Powder coated steel

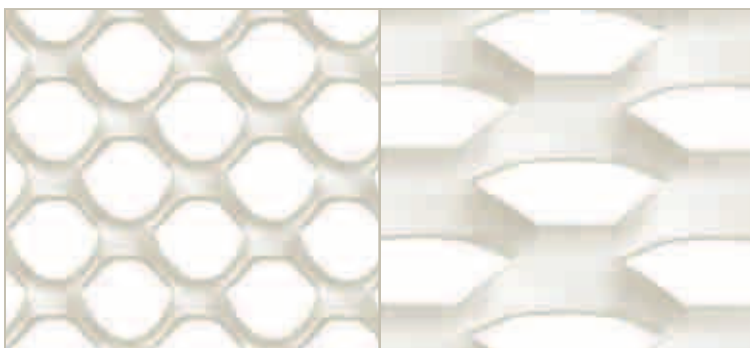

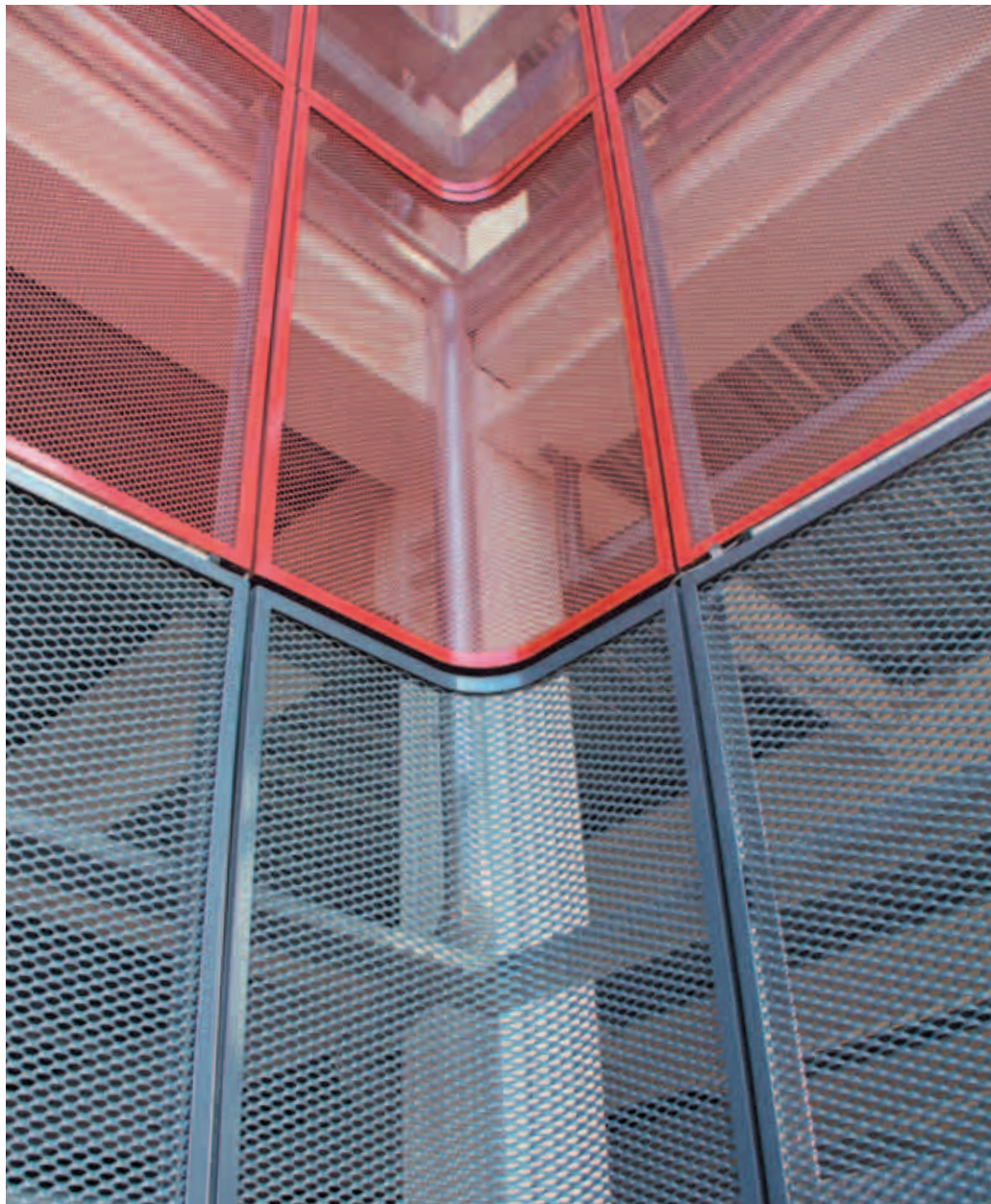



Show room HI-FI - Photo Diecidodici



**Versatility, cutting edge  
and practicality**

“Versatile” is one of the adjectives that best suits this innovative material.

The characteristic aperture of the mesh, the effects of transparency and light make it ideal for show-rooms and displays, stands, partitions and trade fair furniture.

A functional and attractive way to divide spaces by adding curved or folded panels, cut and shaped to size.

The STILTECH line inspires new ideas every day.

# HI-FI SHOW ROOM

## Bergamo (I)



Design: Arch. Dorit Mizrahi  
Photo: Studio Diecidodici



Detail of the overlap  
of the two mesh types  
used to create  
an elliptical wall.

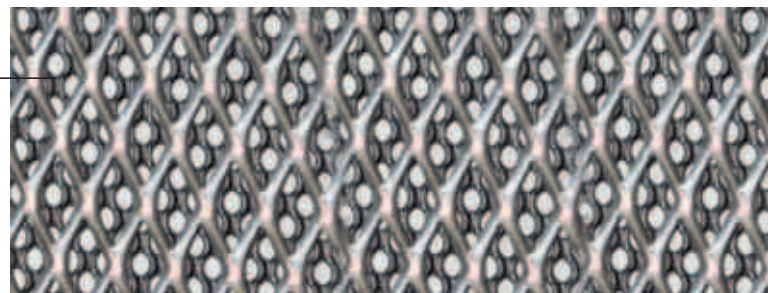

**RB 25** - R 16 x 8 - 2 x 1 mm - Powder coated steel



**ST 6** - 1.3 x 1 - Ø 2.5 mm - Powder coated steel





An original elliptical wall divides this large showroom. Made by using two layers of mesh to create the customer reception area. Expanded metal was also used on the stands with rear illumination.

## MadeExpo BOOTH Milano (I)



Design: Arch. Basilia Barcella  
Photo: ITALFIM Archives

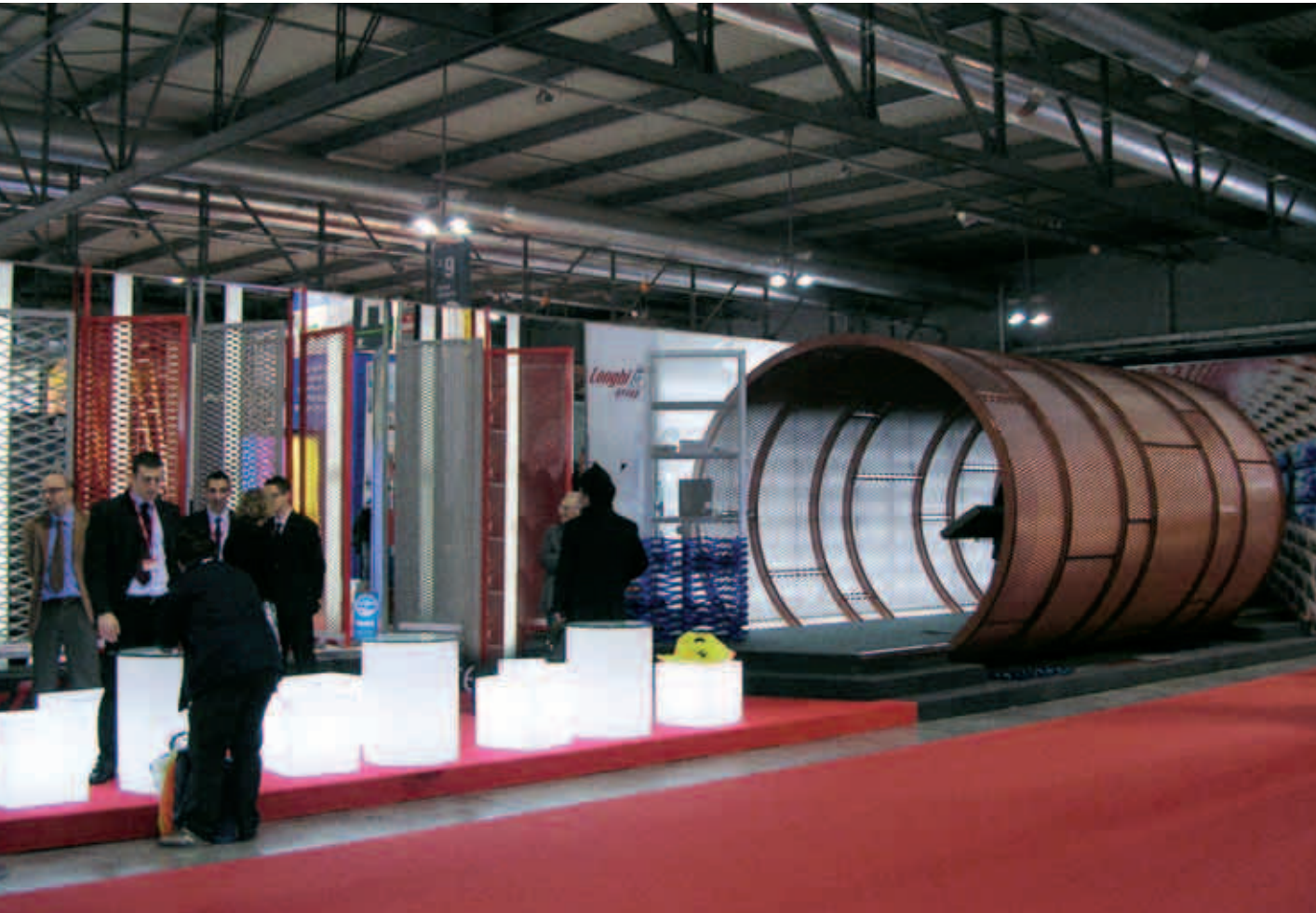

A copper-coloured tunnel houses the booth at the MadeExpo trade fair. Expanded mesh framed and curved panels of different type and size are combined to create a transparent and welcoming shell for the visitors.

**RB 85** - R 100 x 35 - 11 x 1.5 mm - Powder coated steel



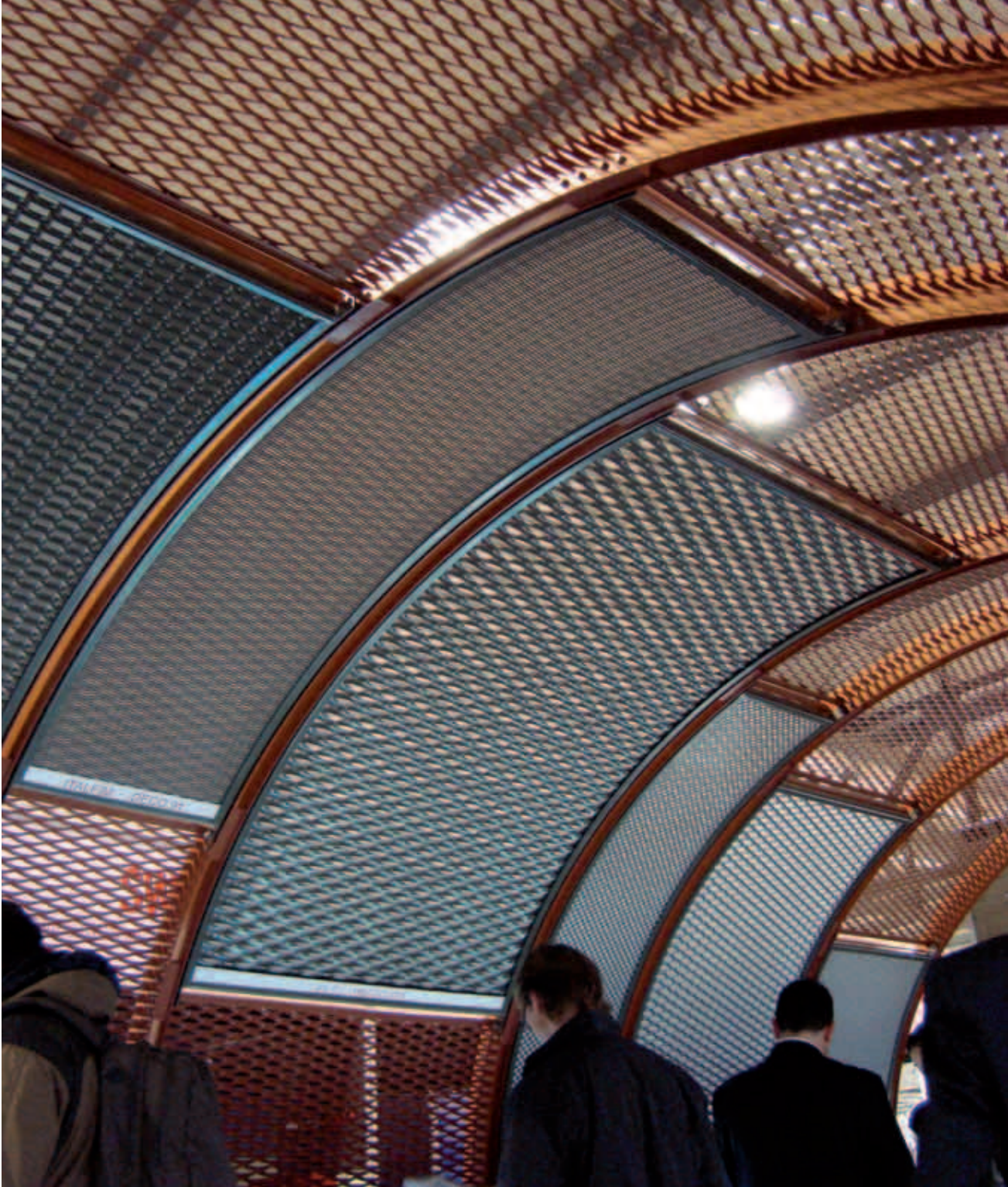

## OUTFITTING AND DESIGN

Backdrops for photo booths, lighting fixtures and prestigious design objects; comfortable seating; easy to use display panels. All in expanded mesh.







Harrods Fashion Lab - London



## PANELS FOR SUSPENDED CEILINGS

### **Functionality, comfort, elegance**

In the office, in the workshop, everywhere: Italfim suspended ceilings can be made to measure to meet the project requirements.

Ceiling solutions that enhance the elegance and design of the room.

Eye-catching personalised colours and quality finishes.

Perfect for a modern look or to create a contrast with a classic style.

A vast range of mesh patterns for a versatile look.

PANELS FOR SUSPENDED CEILINGS

## HARRODS FASHION LAB London (UK)



Design: Found Associates

Photo: Found Associates



A contemporary atmosphere with plenty of light thanks to the suspended metal ceiling of great visual effect in this exclusive London store. The transparent expanded mesh panels support the cabling and lighting fixtures.

**R 110** - R 110 x 40 - 6 x 3 mm - Powder coated aluminium



 **Italfilm**





PANELS FOR SUSPENDED CEILINGS

## MEDICAL ASSOCIATION Baden-Baden (D)



Design: Armstrong  
Photo: U. Beuttemüller



The natural metal colour ceiling tiles (square shaped) give an essential feel to the design.

**RB 25** - R 16 x 8 - 2 x 1 mm - Powder coated pre-galvanized steel

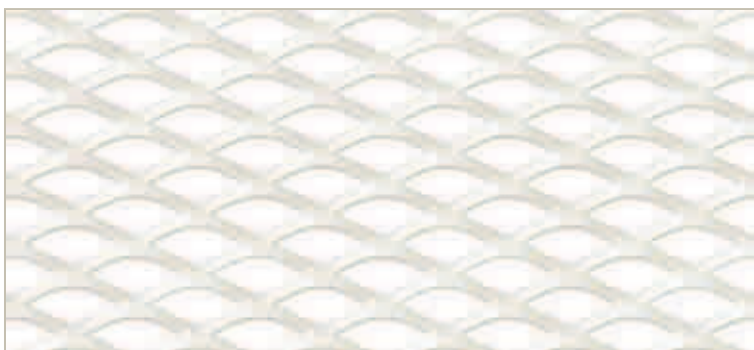

 **Italfim**

Practical housing  
for lights and utilities.



## AIRPORT Frankfurt (D)



Photo: ITALFIM Archives



**ST 10** - 1.6 x 1 - Ø 5 mm - Powder coated pre-galvanized steel

PANELS FOR SUSPENDED CEILINGS

## SHOPPING CENTER LA FIUMARA Genova (I)



Design: Studio Design International of London  
Photo: Foto Proff - Studio Fotografico Genova

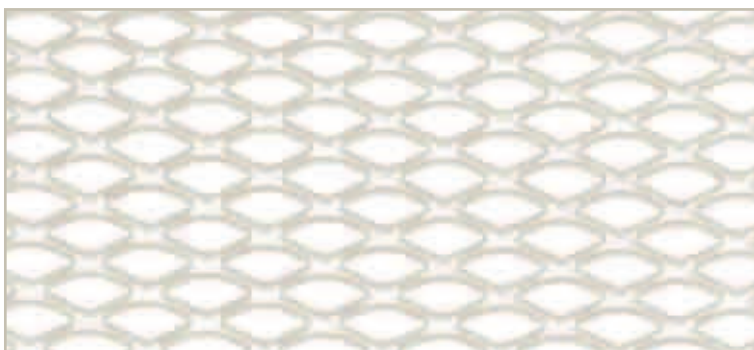

**R 16** - R 16 x 8 - 2 x 1 mm - Natural anodised aluminium

PANELS FOR SUSPENDED CEILINGS

## SHOW ROOM Bergamo (I)



Design: Arch. Basilia Barcella  
Photo: Archivio ITALFIM



**Ralf** - Natural aluminium

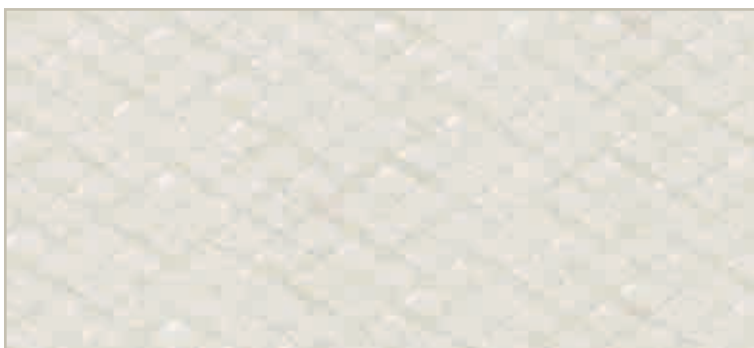



PANELS FOR SUSPENDED CEILINGS

## H&M STORE Hamburg (D)



Design: Patricia Urquiola  
Realization: DELTASYSTEM INTERNATIONAL  
Photo: LONGHIGROUP Archives



ST30 - 6 x 2 - Ø 15 mm - Powder coated aluminium



PANELS FOR SUSPENDED CEILINGS

## SCHLOSS LEUK Leuk (CH)

Design: Arch. Mario Botta  
Photo: Metallpfister



**ST 10** - ST 10 x 7.3 - 1.6 x 1 - Ø 5 mm - Powder coated steel

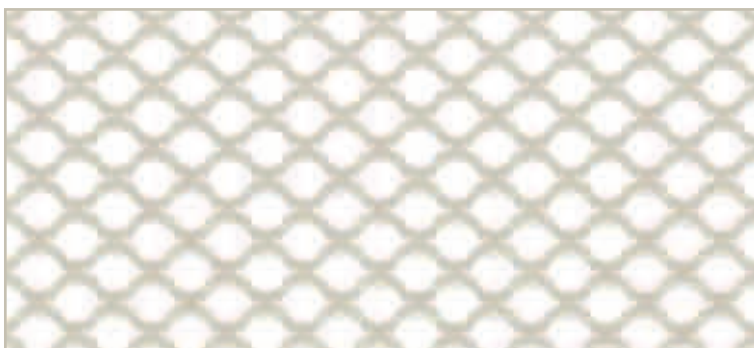

## PANELS FOR PARAPETS



An interesting match of old and new, stone and metal for a castle in an astonishing setting.

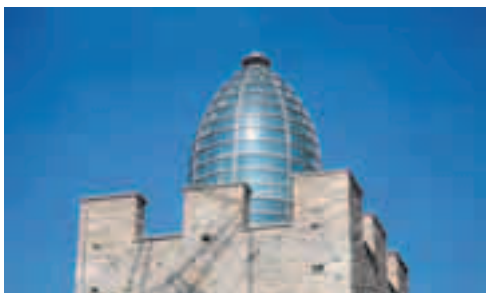

**ST 16** - ST 16 x 13 - 3 x 2 - Ø 8 mm - Powder coated steel



SUSPENDED CEILINGS

## INDUSTRIAL COMPANY Pedrengo - Bergamo (I)



Design: Arch. Basilia Barcella  
Photo: Studio Diecidodici



A pleasing combination of red glass vertical walls and the metal suspended ceiling. The rectangular ceiling tiles are made from expanded mesh with a fine pattern.

**ST 8** - 1.5 x 1 - Ø 3 mm  
Powder coated steel

**KD200** - Q8 x 6 - 1.2 x 1 ■  
Powder coated steel

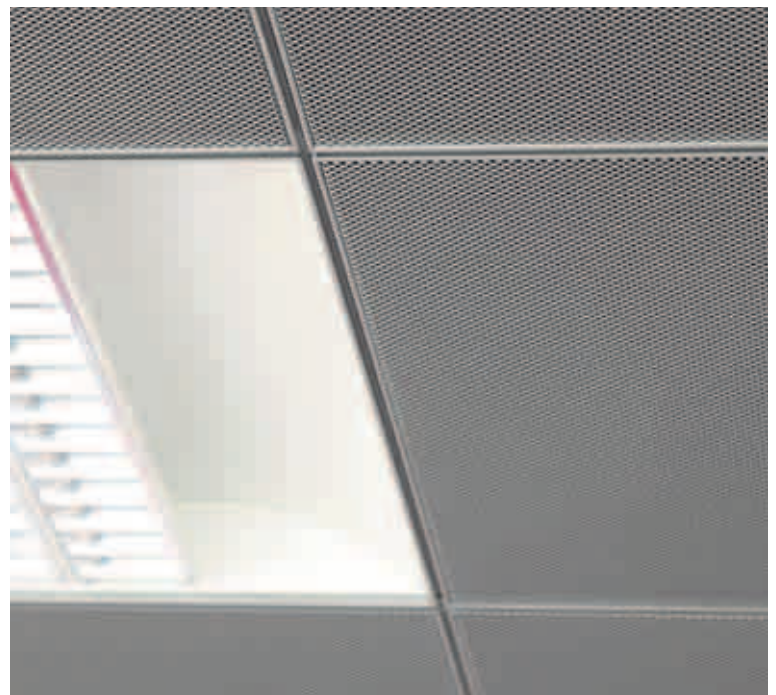

 **Italim**



## STANDARD MODULES FOR SUSPENDED CEILINGS

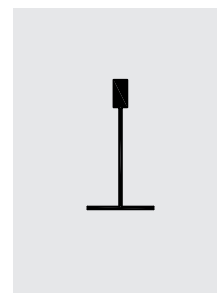

Mounting grid profile  
(not supplied).

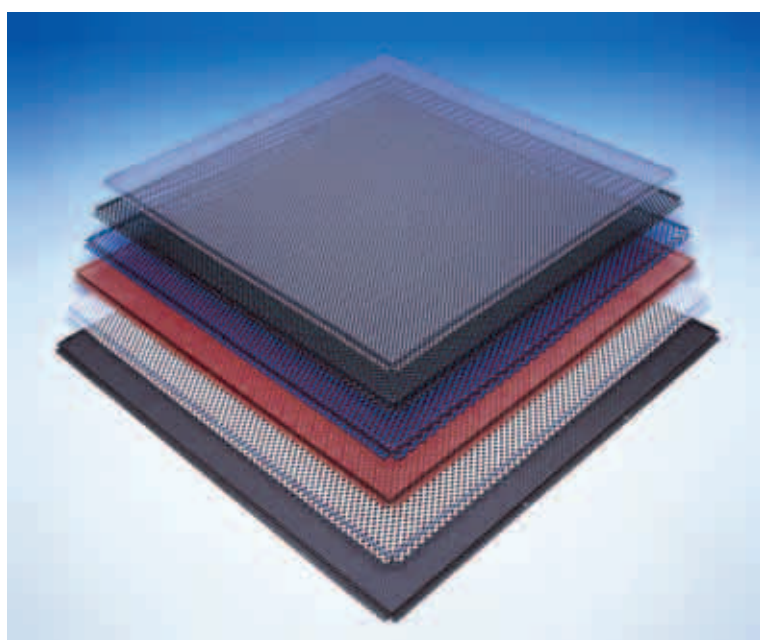
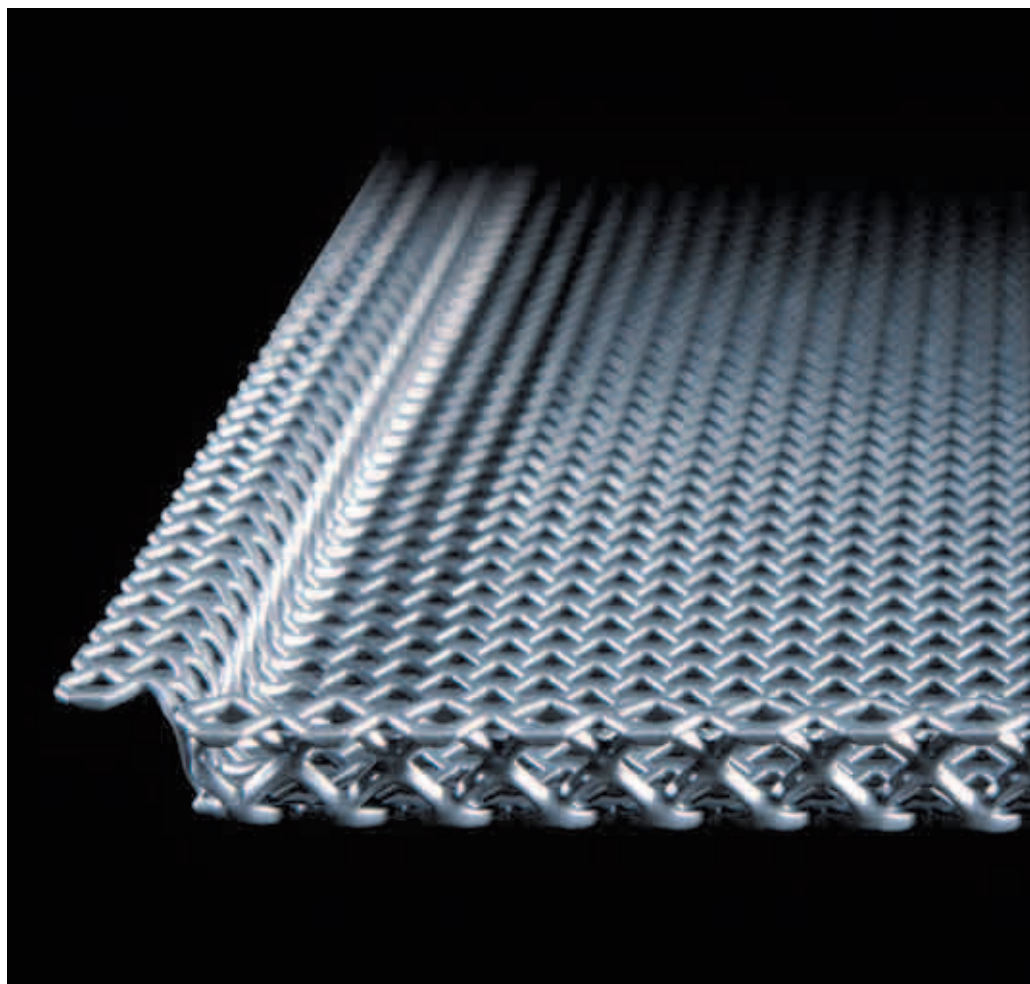

### **Colour effect**

A rich range of stable and lasting colours due to the use of epoxy-polyester power coating for interiors. Available in all RAL colours.

### **Trouble-free installation**

This Italfim panel is easily installed on various types of supporting structure. Contact your trusted installer for the best result. Contact us for further information.

### **Practical solutions when you need them**

You can now easily service and check out your utility equipment by simply removing a panel without the need of special tools.

**Lay-in types. Lay in tiles with T-profile mounting grid in view**

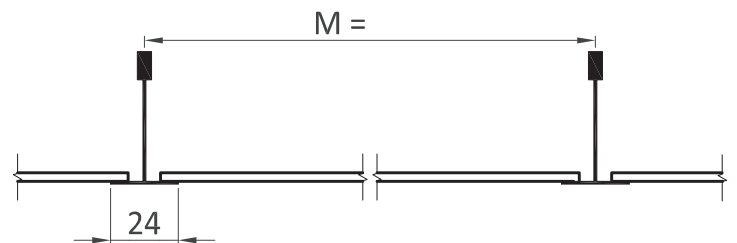
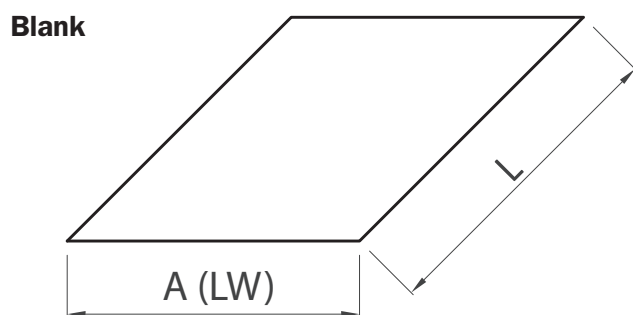
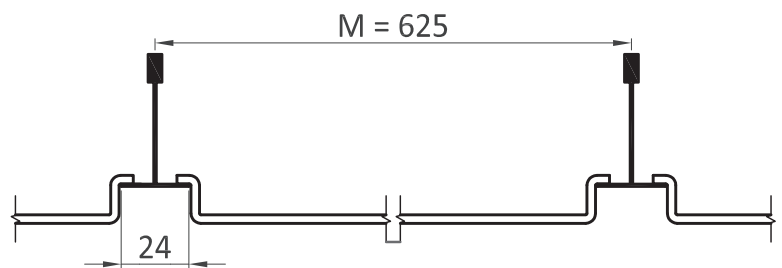
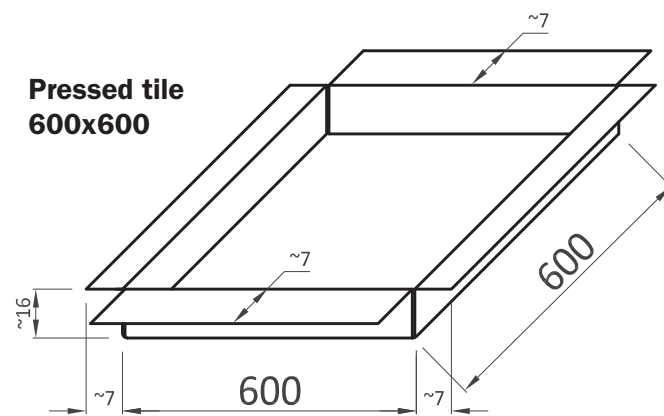
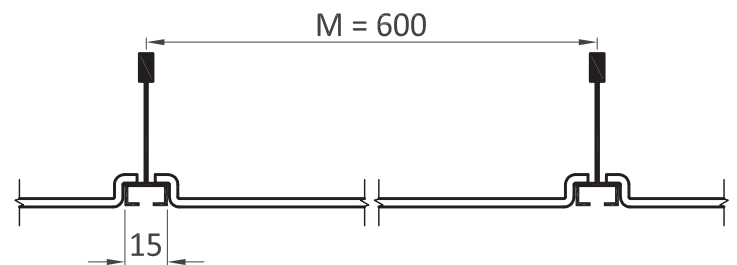
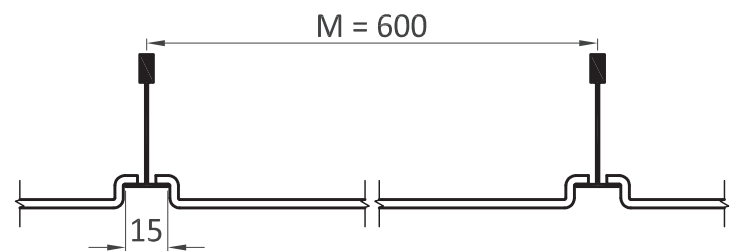
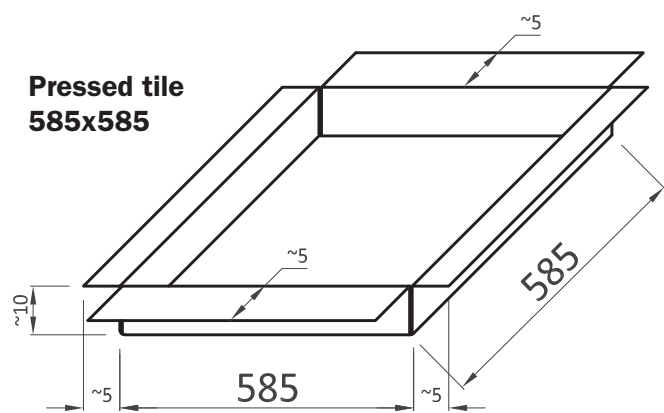
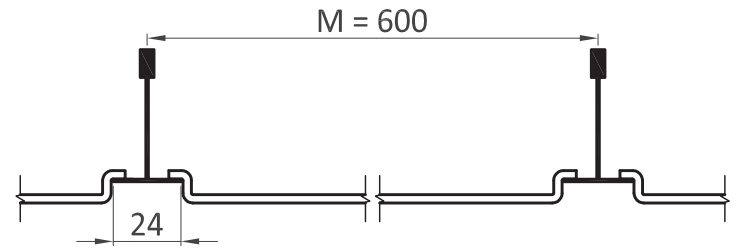
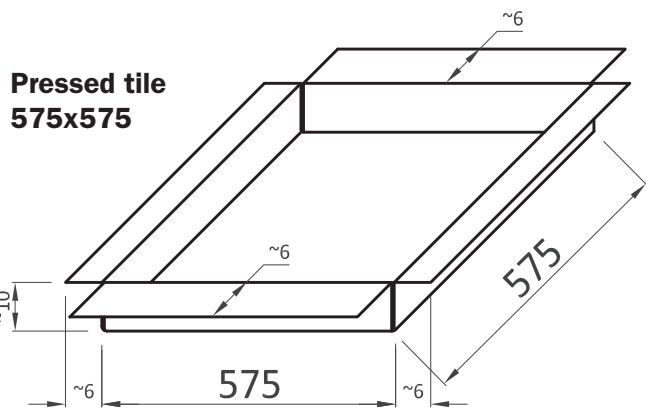

**Blanks can be made to measure to sit directly on the mounting grid (with no folded edges).**

**M = Distance between centres of mounting grid  
Dimensions in millimetres (mm)**

## BESPOKE SIZE CEILING TILES WITH REINFORCING PROFILES AND FOLDED MESH

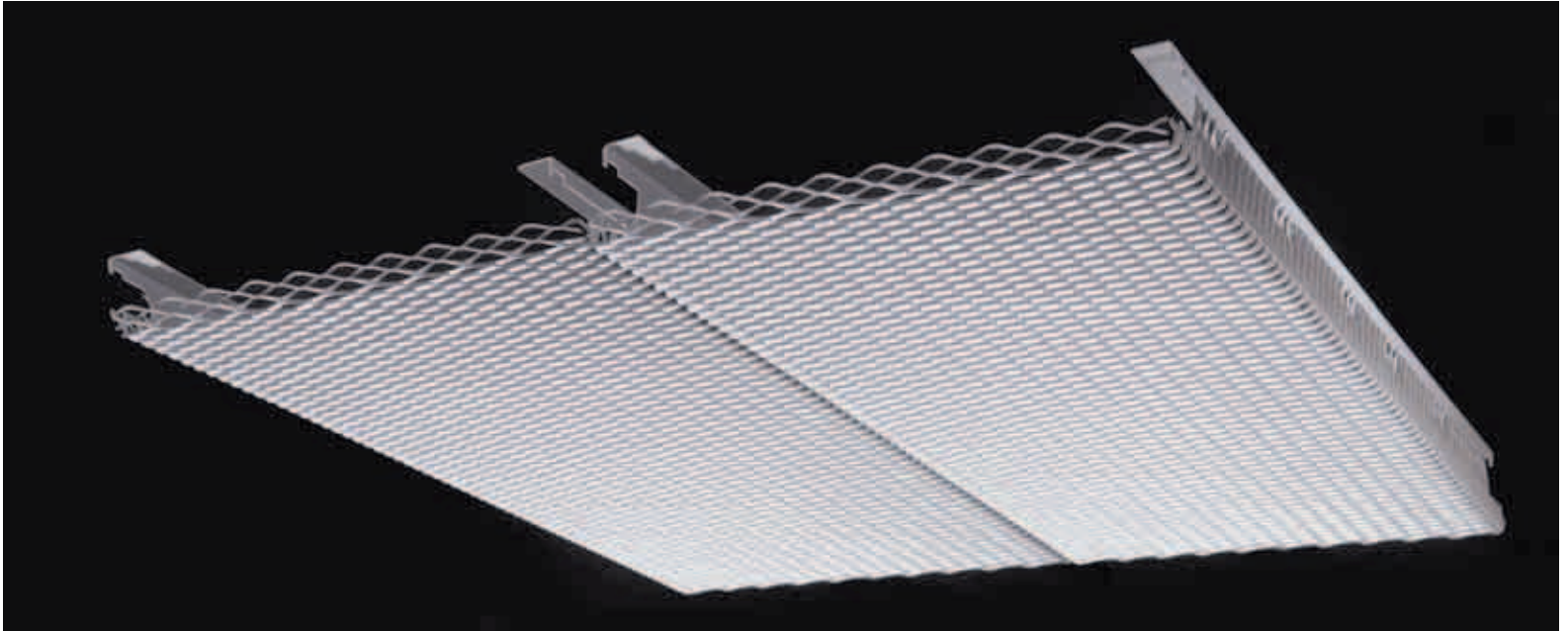

Folded mesh externally fixed to reinforcing profiles.

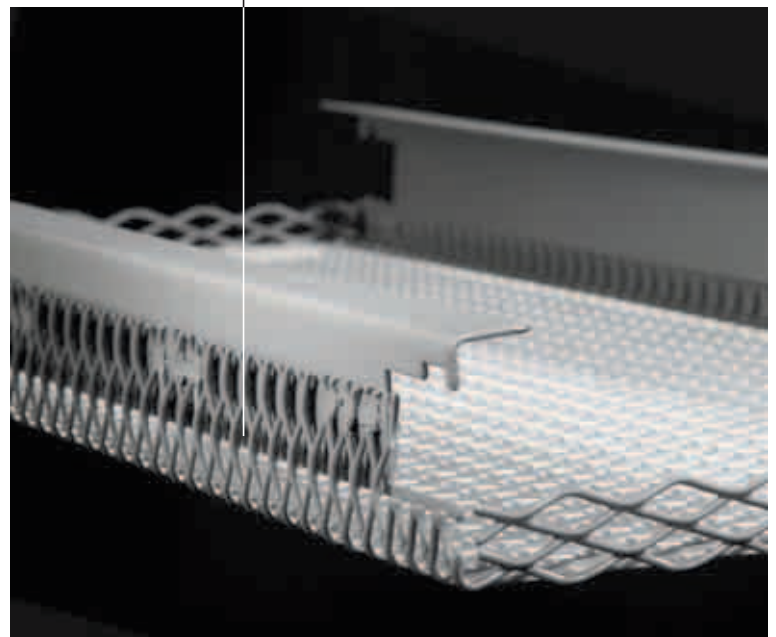
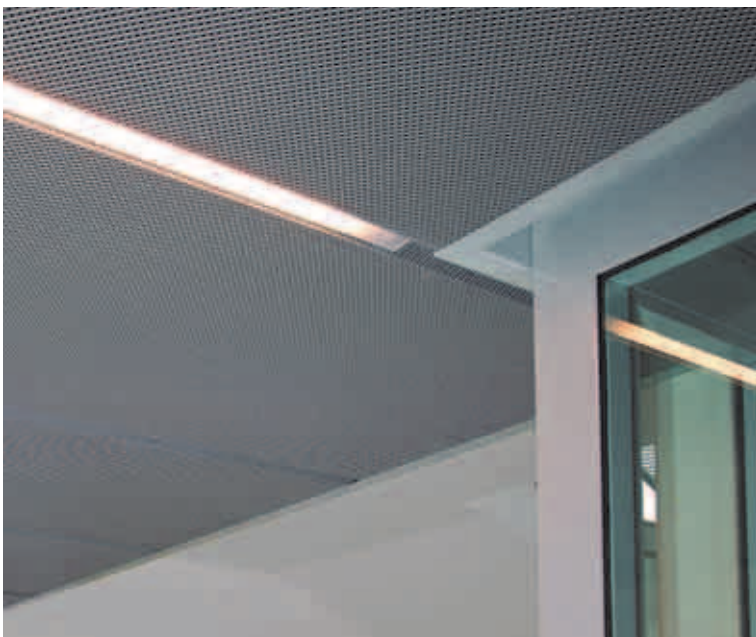



**Lay-in types. Lay in tiles with mounting grid in view**

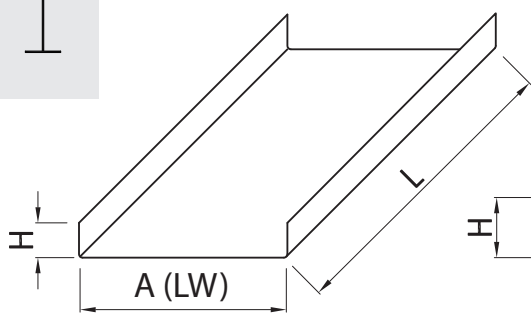
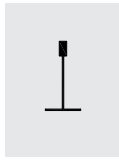

**D1**

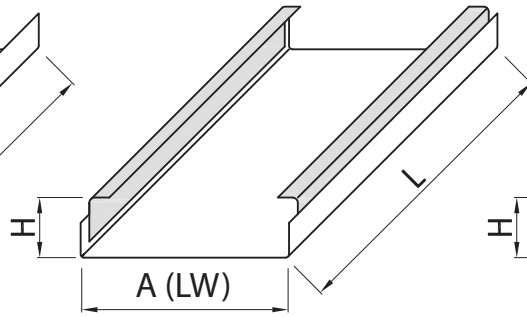

**D5**

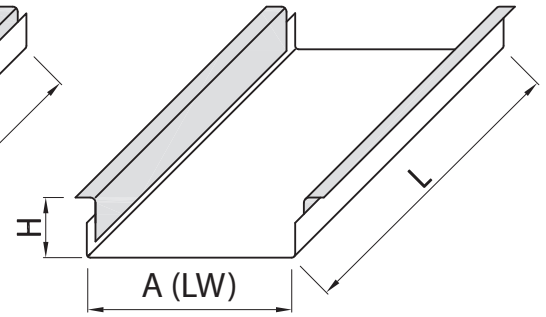

**D4**

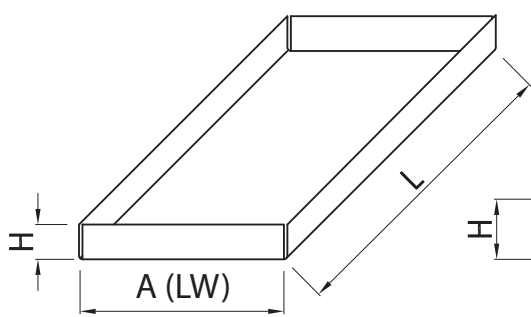

**D1s**

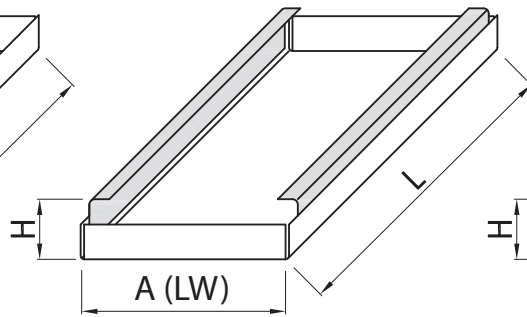

**D5s**

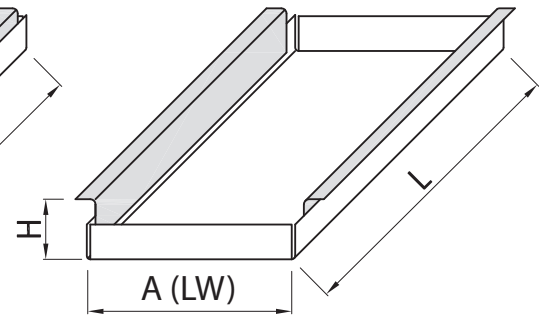

**D4s**

**Hook-on types. Tile fixing to concealed mounting grid**

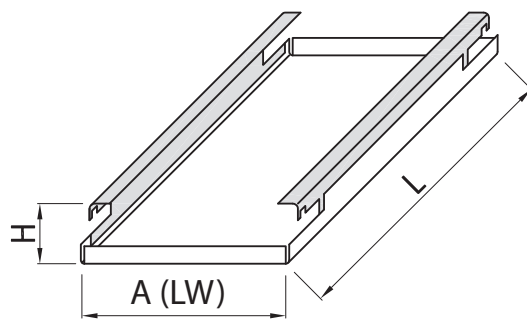
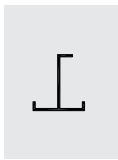

**D11s**

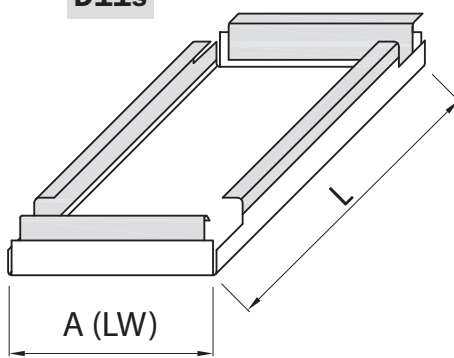
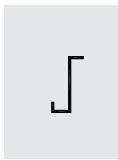

**D91s**

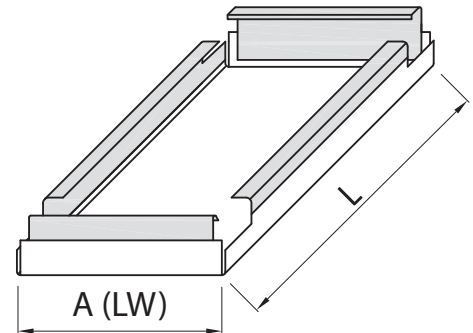

**D92s**

**BESPOKE SIZE CEILING TILES WITH REINFORCING PROFILES.  
FLUSH EDGE, NO FOLDED MESH**

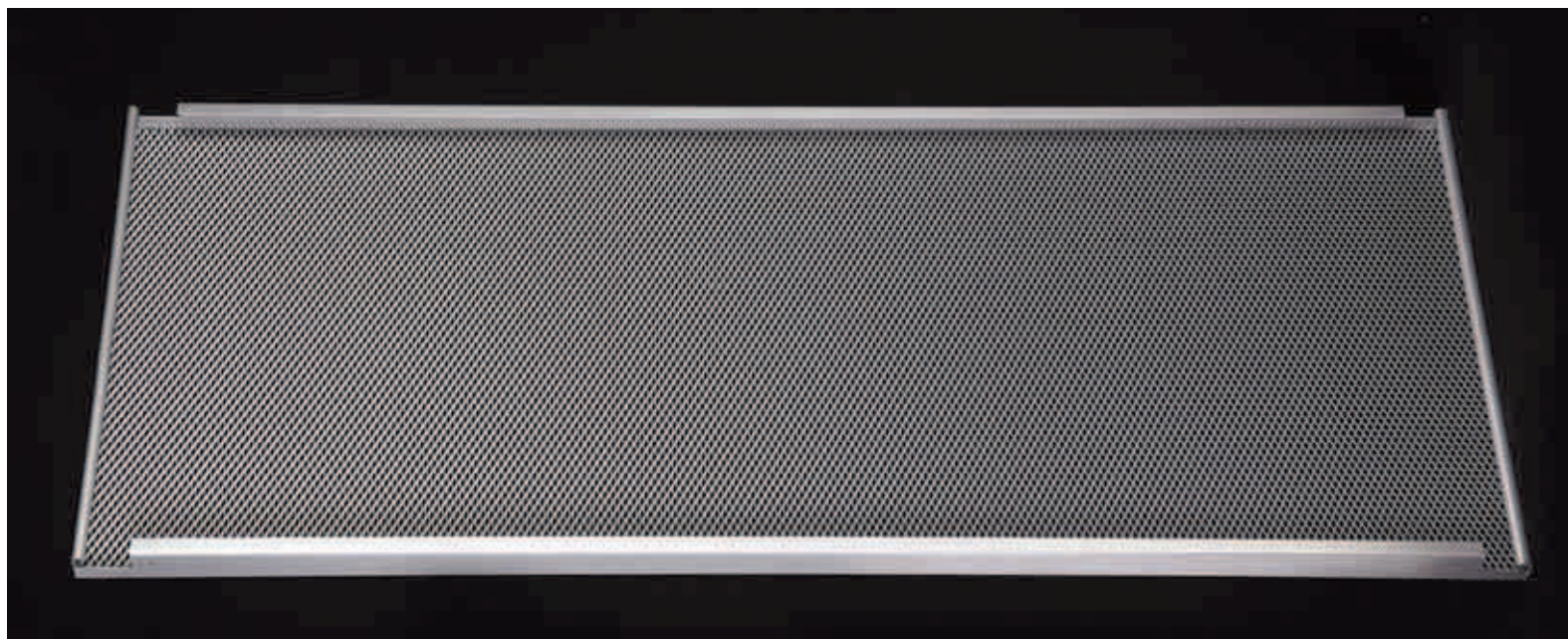

**Hook-on types. Tile fixing to concealed mounting grid**

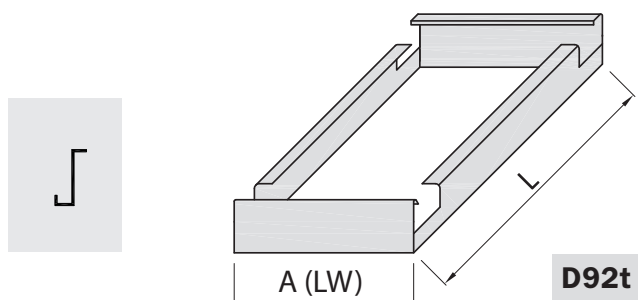
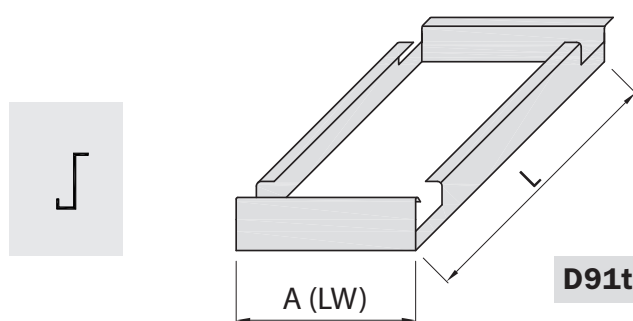
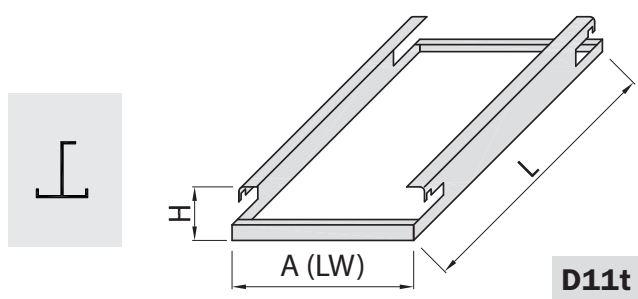

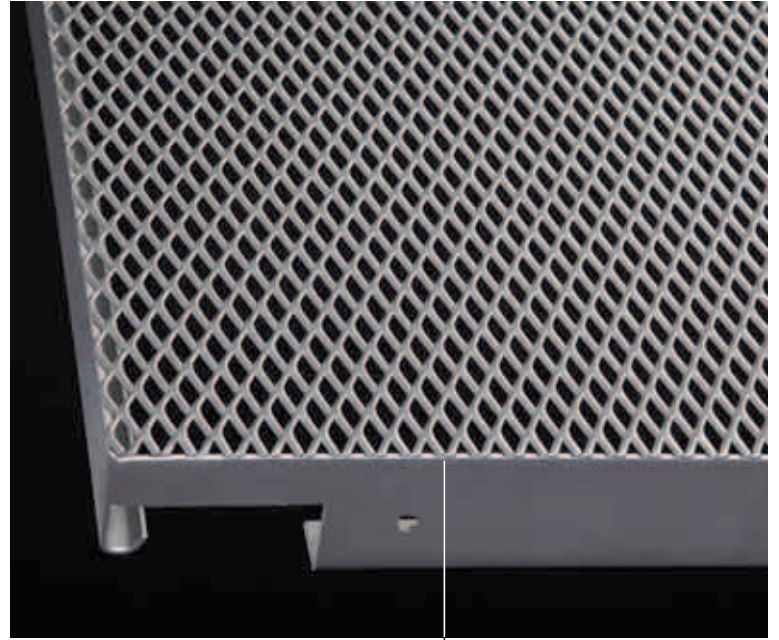

Fixing of the mesh to the reinforcing structure along the perimeter.





## PARAPETS AND FENCES

### **Aesthetics, originality, protection**

Small or big, it does not matter. Parapets and fences are key elements to enhance the design of the project.

They are also features engineered to protect people and they need to be accurately designed with that function in mind.



# ROTKREUZHAUS Basel (CH)



Design: Arch. Forsberg Architekten AG  
Photo: Tom Bisig



TAU 60 - T 30 - 6 x 2 mm - Ø 15 mm - Powder coated pre-galvanized steel





## “QUARTOVERDE” DISTRICT

Design: Arch. Studio De8

Photo: ITALFIM Archives

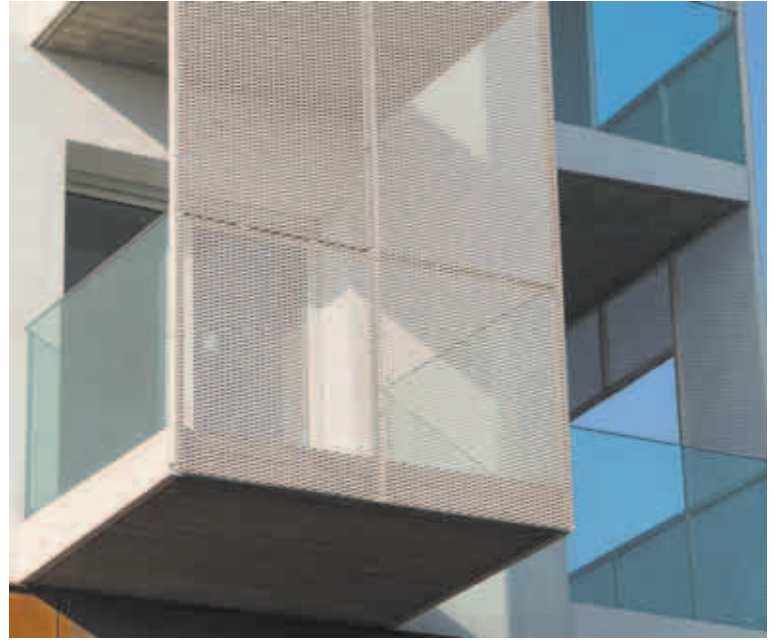

**RB 45** - R 28 x 14 - 5 x 2 mm - Powder coated pre-galvanized steel



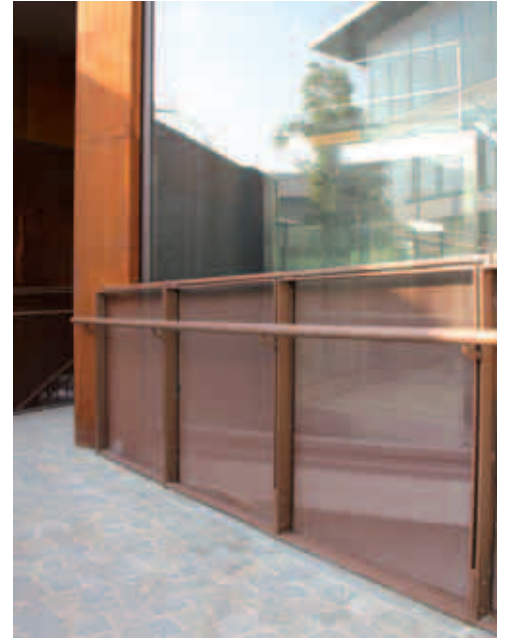

**RB 65** - R 62 x 23 - 8 x 1.5 mm - Powder coated pre-galvanized steel

## RESIDENTIAL PROPERTY

Design: Studio Capitanio Arch.  
Photo: ITALFIM Archives



**ST 20** - 3.25 x 3 - Ø 10 mm - Natural aluminium

## ELEVATED CYCLING LANE

Design: Arch. Lisa Oprandi

Photo: ITALFIM Archives



ST 16 - 3 x 2 - Ø 8 mm - Hot dip galvanized steel

## HALFWAY HOUSE

Design: Ing. A. Caneva Zanini - Arch. M. Zeduri  
Photo: Studio Diecidodici

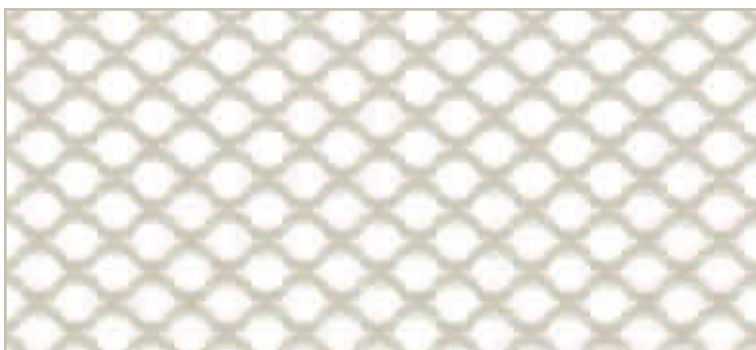

ST 10 - 1.6 x 1 - Ø 5 mm - Powder coated pre-galvanized steel

## NURSERY

Design: ITALFIM Archives

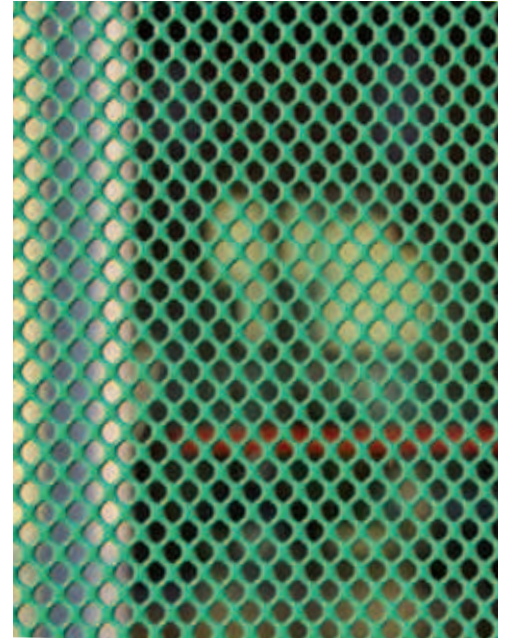

**ST 10** - 1.6 x 2 - Ø 5 mm - Powder coated pre-galvanized steel

## COLOURS AND PROTECTING FINISHES

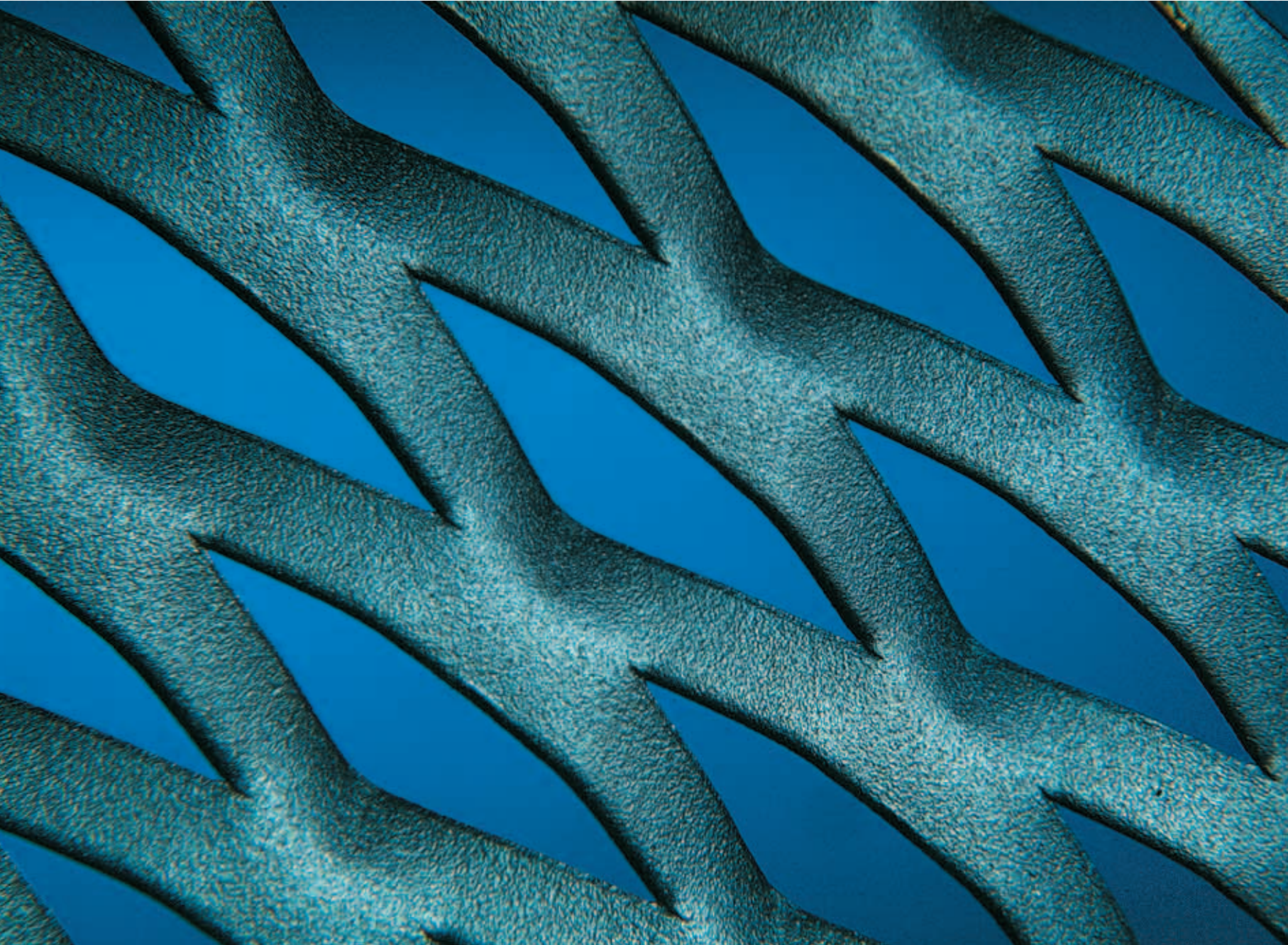

## FINISH COMPARISON

	CARBON STEEL + HOT DIP GALVANISING	CARBON STEEL + POWDER COATING FOR INDOOR	SENDZIMIR CARBON STEEL + POWDER COATING FOR INDOOR/OUTDOOR	ALUMINIUM + POWDER COATING FOR INDOOR/OUTDOOR	ALUMINIUM + ANODISING FOR INDOOR/OUTDOOR
Colour spectrum					
Corrosion resistance	★★★★★	★★★	★★★	★★★★★	★★★★★

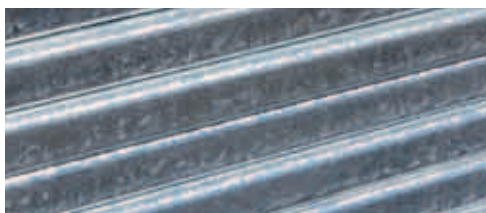

### Hot-dip galvanizing

Hot-dip galvanizing is a surface coating treatment for the protection of metals based on the properties of molten zinc. Note that a hot-dip galvanized surface appears bright and shiny at first and it assumes a typical matt grey color over time.



### Powder coating

In addition to the vast range of colours to personalize the design project powder coating also provides protection against corrosion. Different types of powder coating are available: epoxy resin, polyester, and epoxy-polyester coating, depending on the requirements.



### Anodizing

Anodizing is a chemical electric process aimed to create a layer of oxide on the surface of aluminum. The layer provides protection against corrosion.

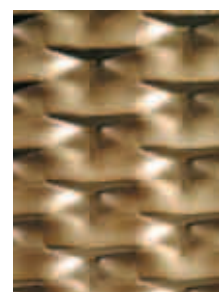
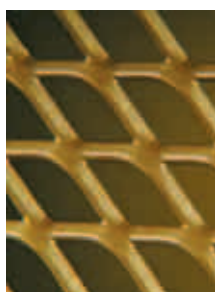
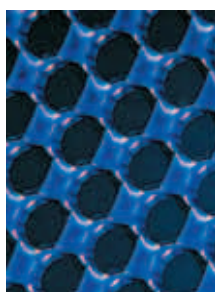

## INNOVATIVE SOLUTIONS

METALLTECH (a Longhi Group partner) specialises in providing assistance during the design and engineering of expanded mesh cladding.

Thanks to research and innovation, some exclusive methods of processing expanded mesh have been developed.

Mesh MTC - LV - 43S - Metalltech Patented

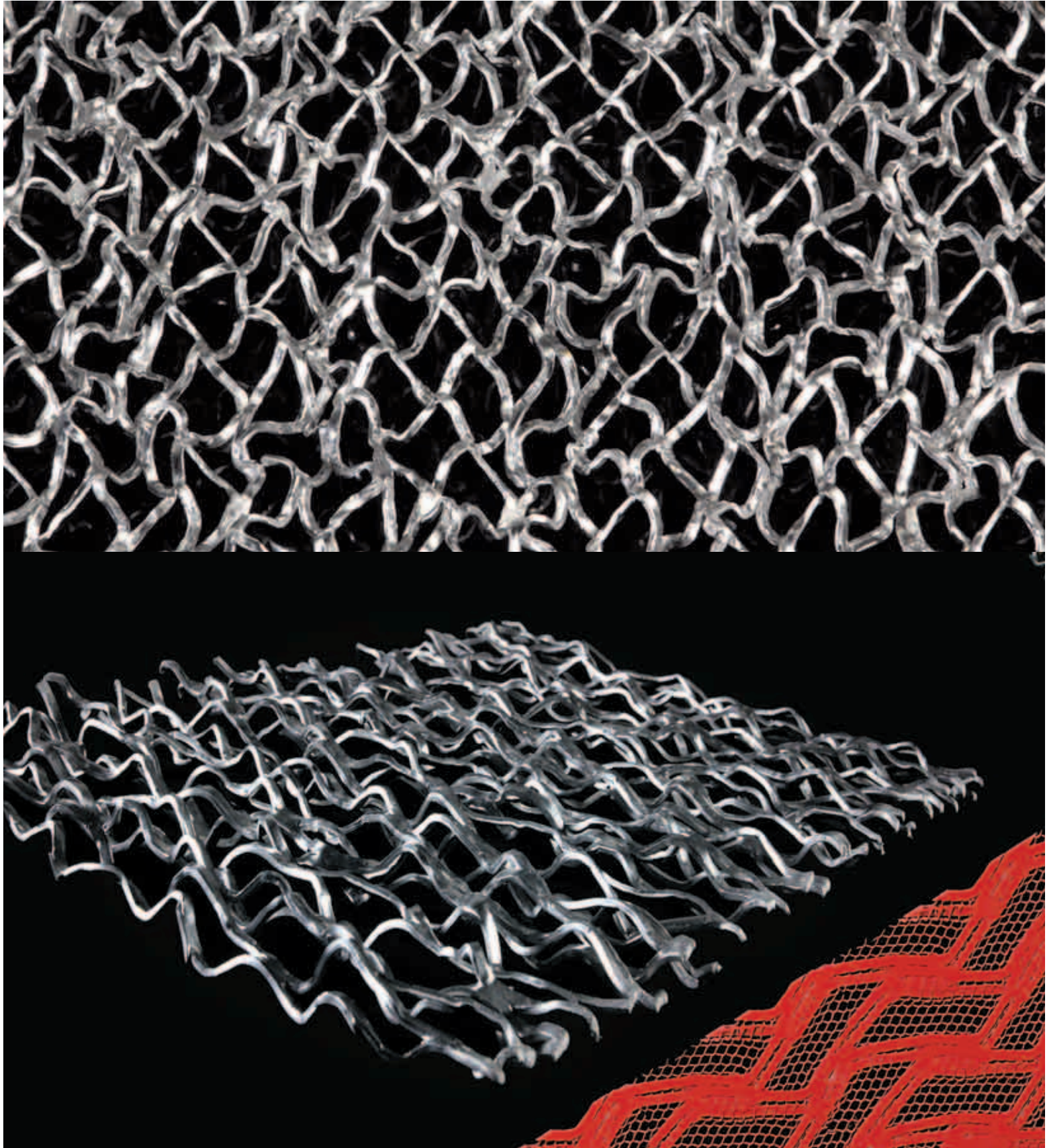



Mesh MTC - LV - 20S - Metalltech Patented

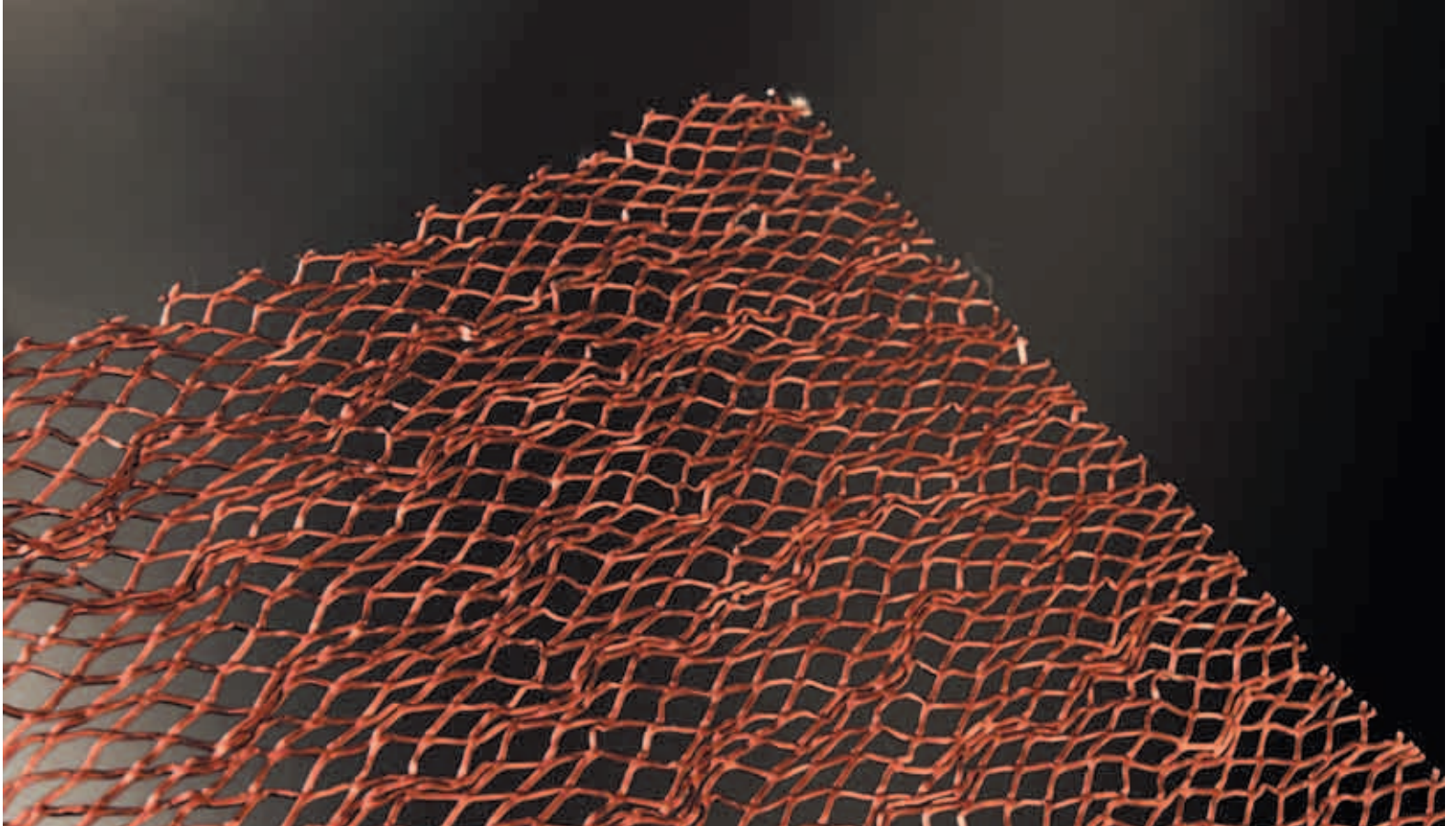
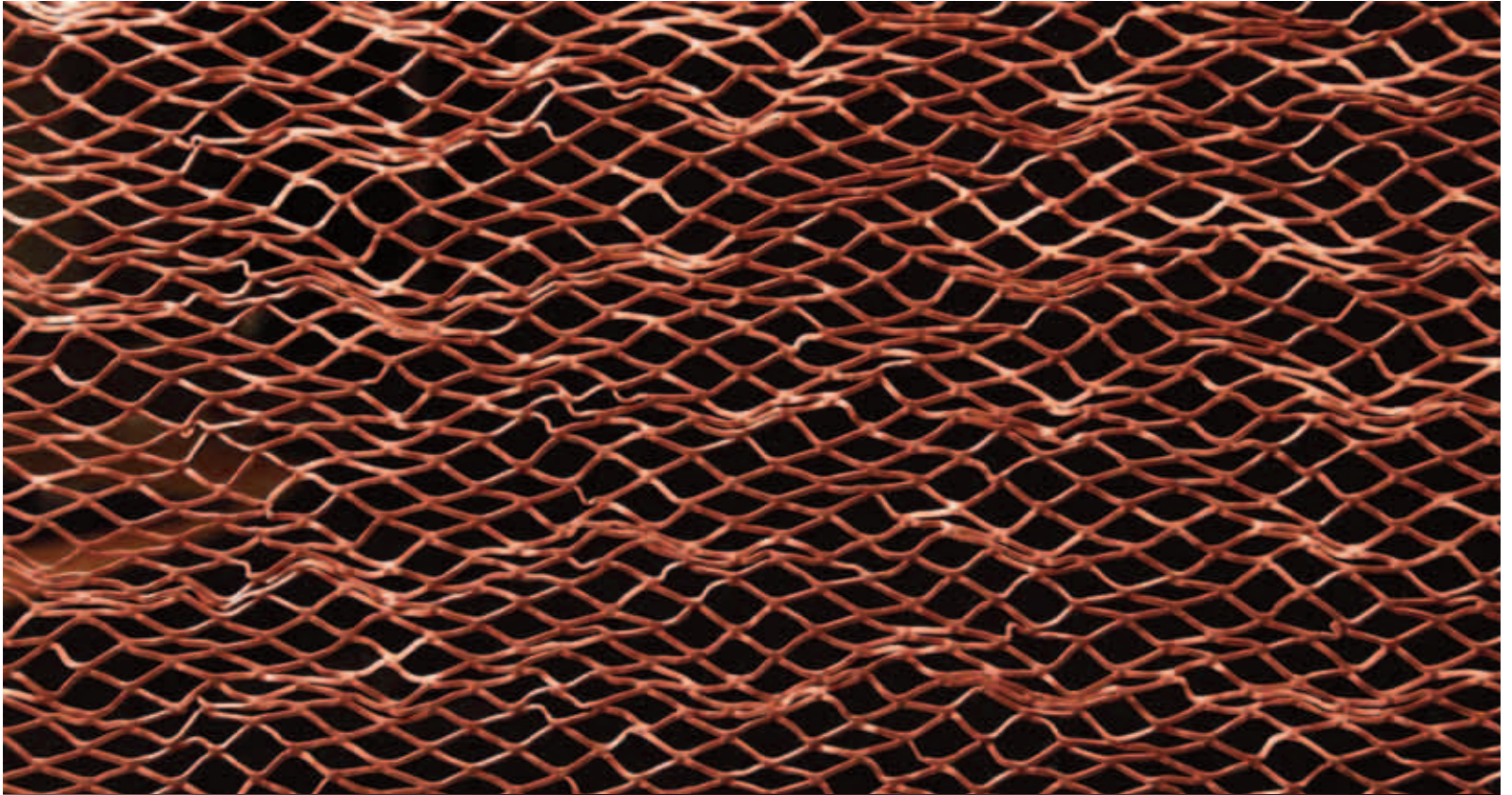

Mesh MTC - LS - 29 - Metalltech Patented

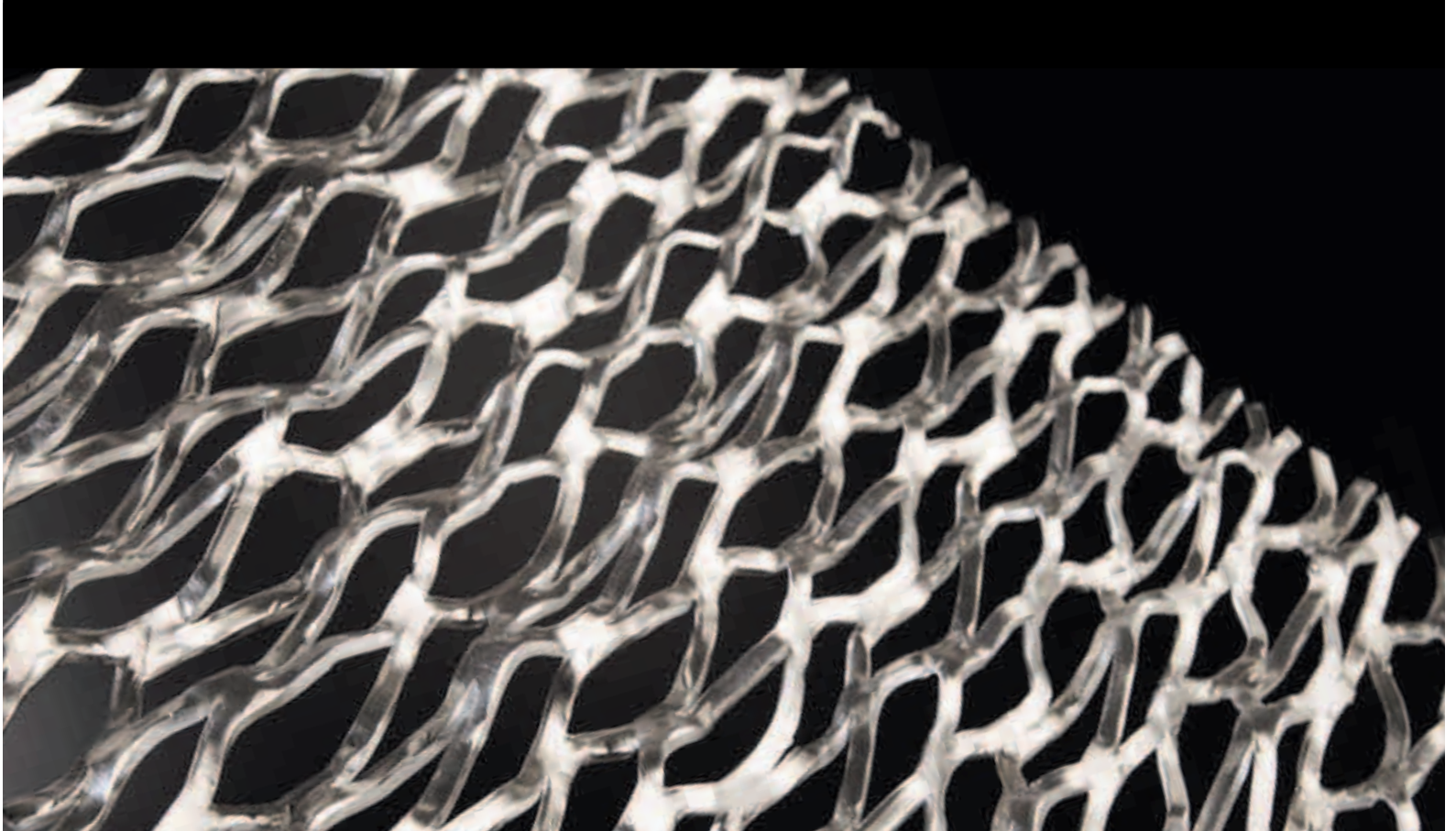
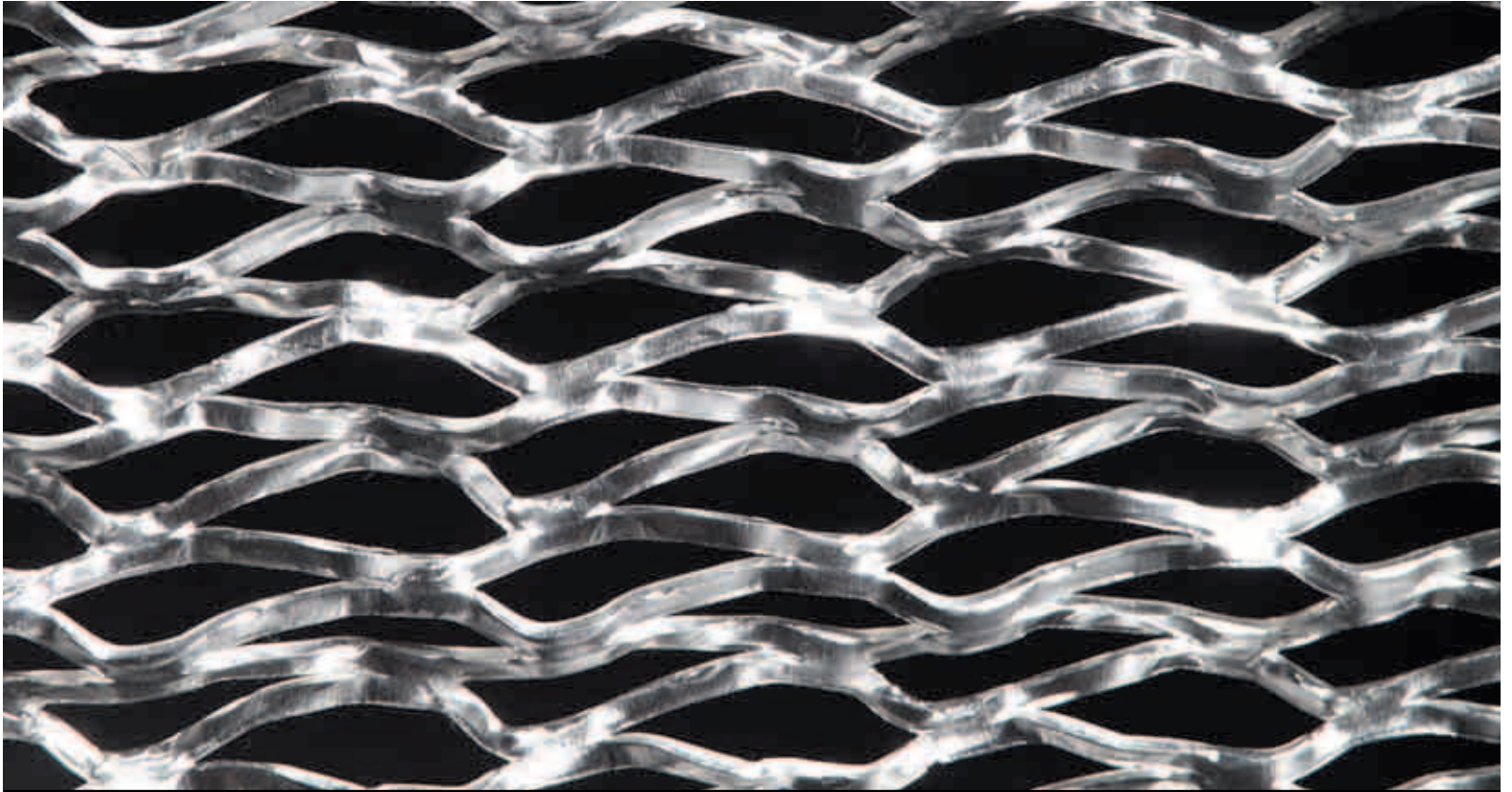

Mesh MTC - LV - 28 - Metalltech Patented

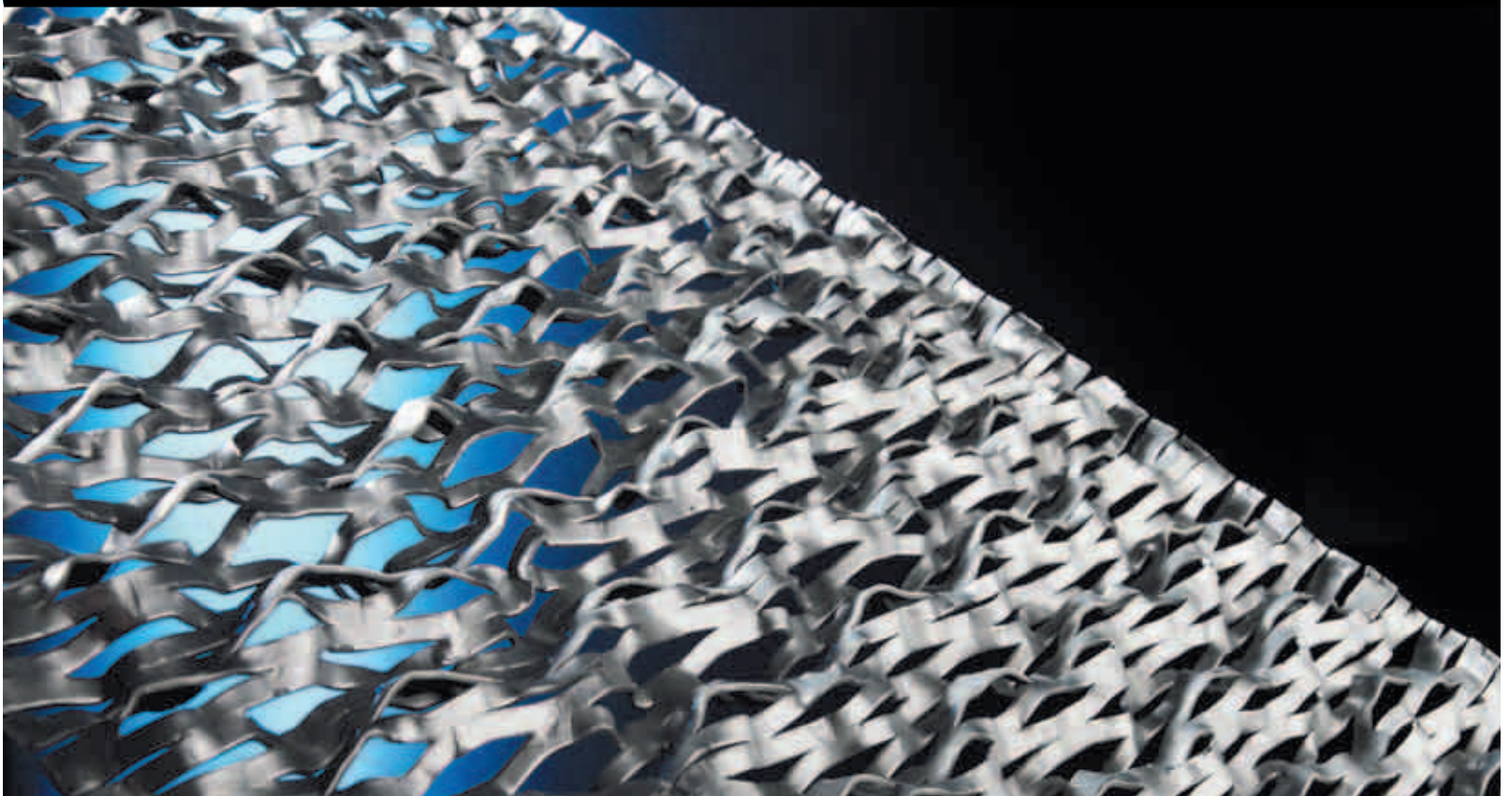
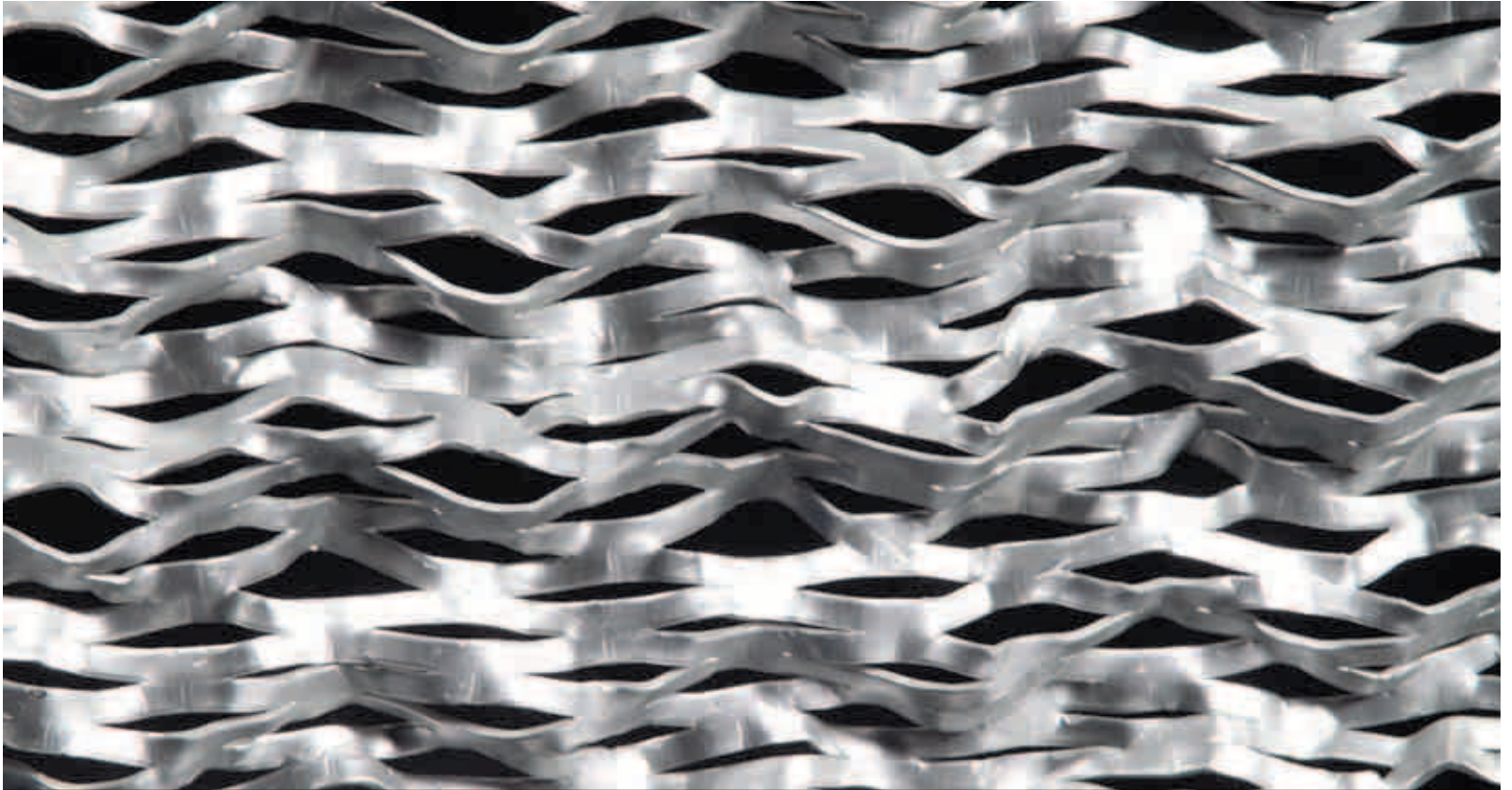

## MODULARITY

Surfaces of any shape and size can be created.  
Expanded mesh can be cut, folded and curved.  
Panels are available in standard dimensions.  
Panels manufactured to size are also available on request.

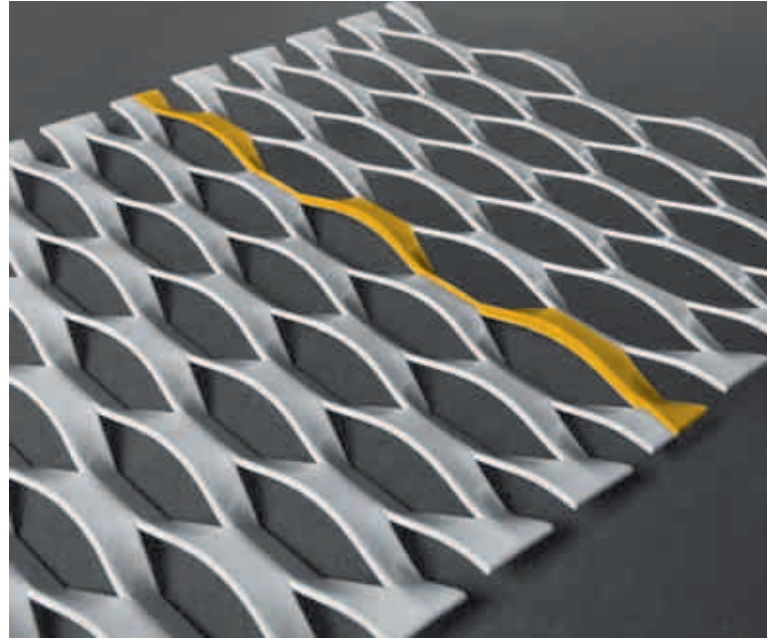
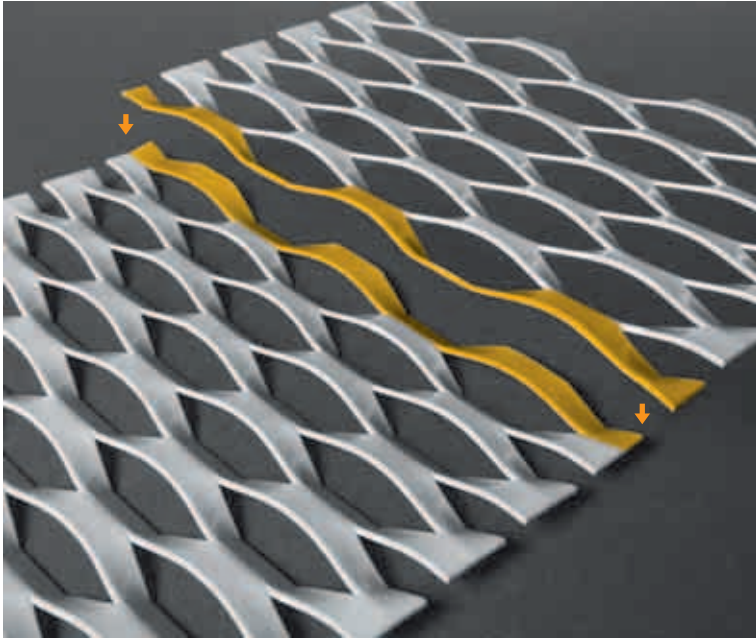

OVERLAP OF HALF A MESH - MESH SIDE "A" IN VIEW

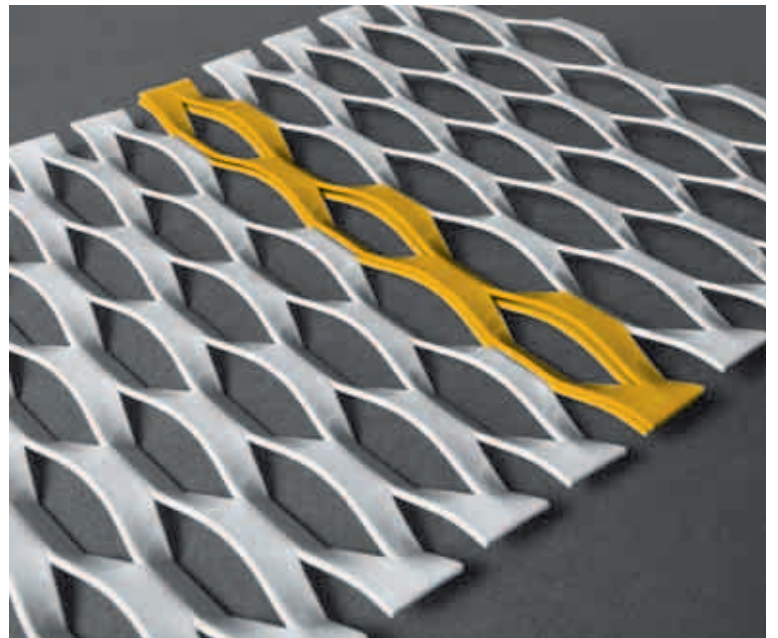
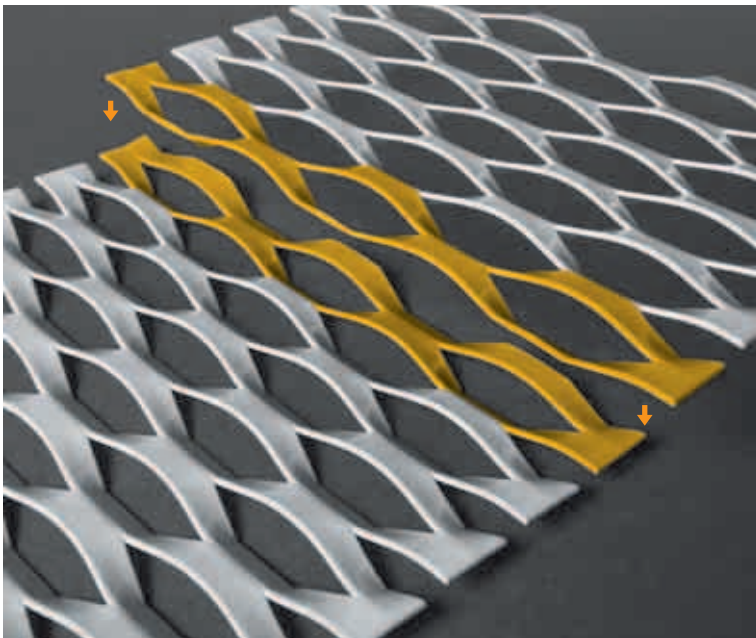

OVERLAP OF ONE COMPLETE MESH - MESH SIDE "A" IN VIEW

INFORMATION FOR USE IN MODULAR CONFIGURATION

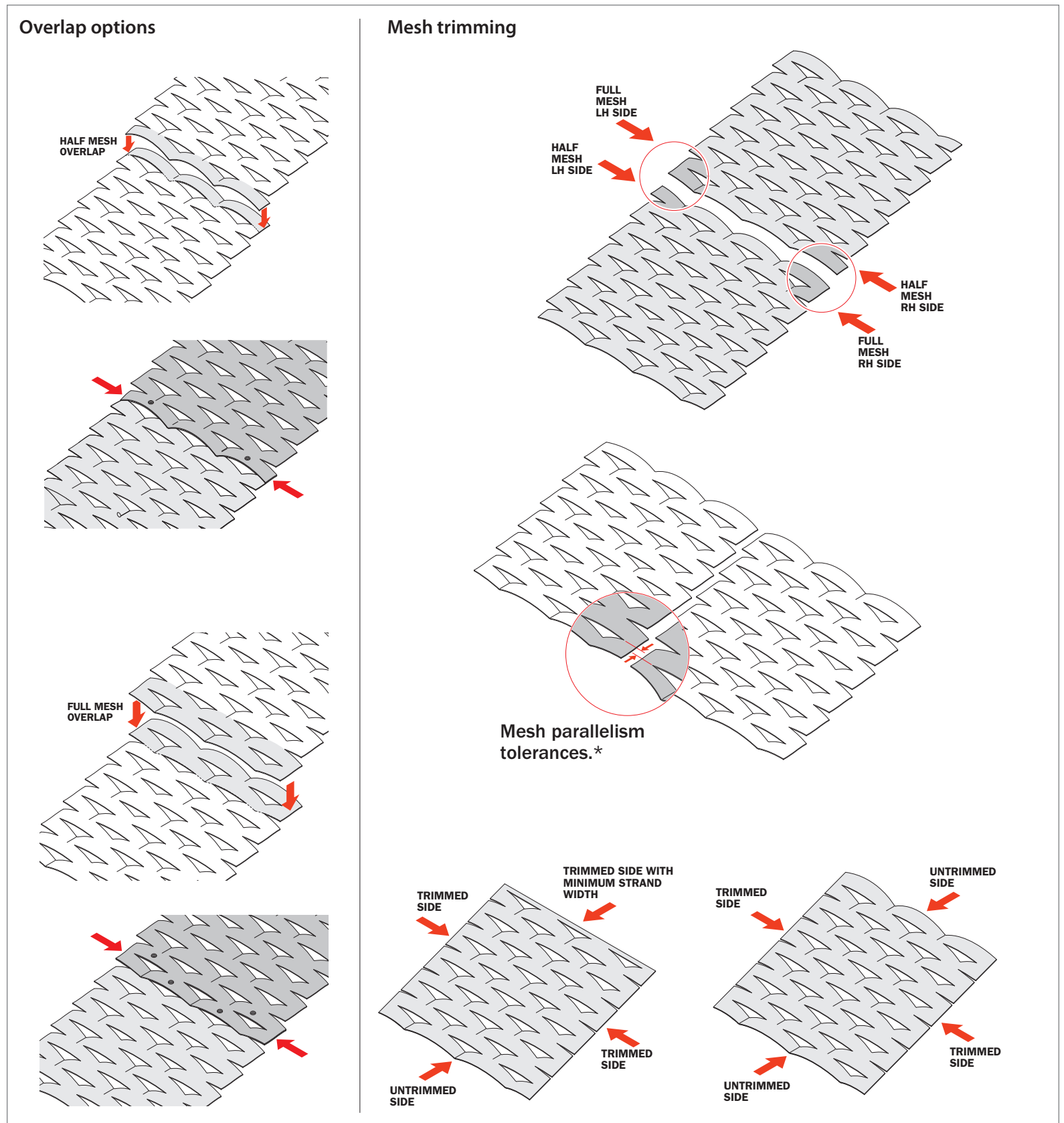

\* Please contact our experts for further details about production tolerances

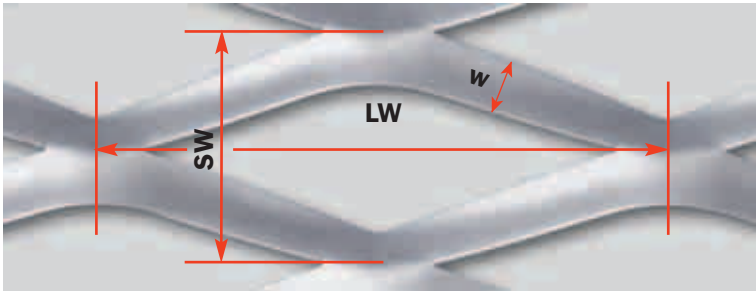

**SPECIFYING DIAMOND MESHES**

- LW** Long way pitch
- SW** Short way pitch
- w** Strand Width
- t** Thickness

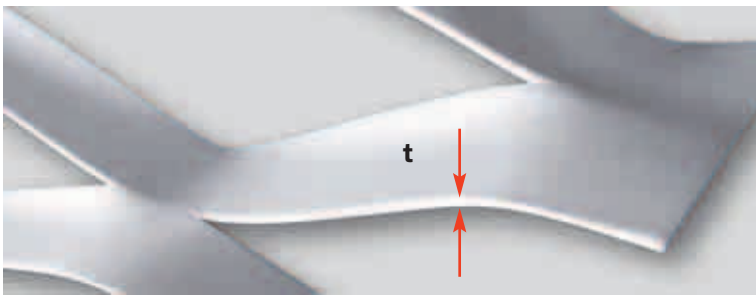

**EXAMPLE MESH RB 45**  
DIMENSIONS IN MM

**R 28 x 14 - 5 x t**  
|TYPE| LW | SW | w | t

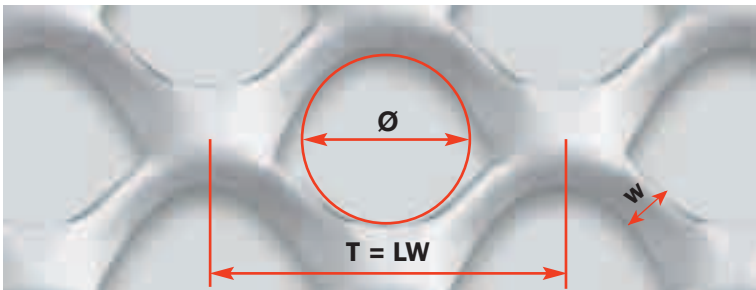

**SPECIFYING ROUND HOLE OR "T" MESHES**

- T = LW** Long way pitch
- w** Strand Width
- t** Thickness
- Ø** Inscribed circle diameter (~)
- T** = Round hole patterns, **not flattened mesh**

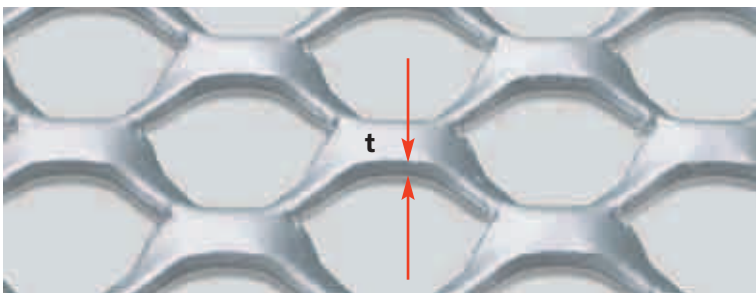

**EXAMPLE MESH TAU 40**  
DIMENSIONS IN MM

**T 20 - 3.25 x t - Ø10**  
|TYPE| LW | w | t | Inscribed circle diameter

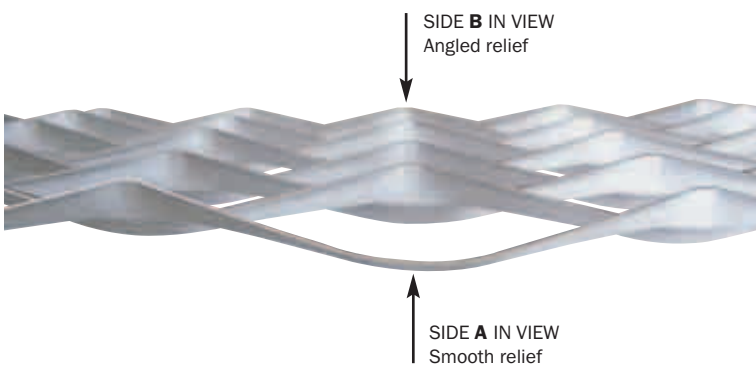

**● IMPORTANT NOTE**

In order to dimension correctly any framing profile, it is re-recommendable to measure the sheet thickness along the perimeter. The final sheet thickness at the perimeter may differ from the nominal value indicated on the data sheet.

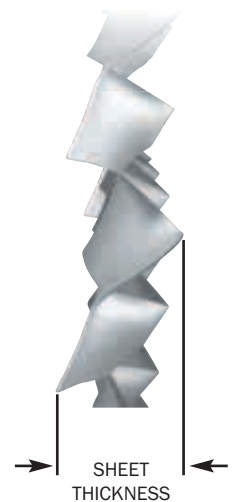

### **The idea takes shape**

Point, line, plain, space.  
The project takes shape with vertical and horizontal elevations. Italfim's STILTECH mesh line catches the eye with geometric perceptions and personalised colours. Suspended ceilings, façades, flat or curved surfaces for endless applications: each solution will look smart and unique.

# TAU 10

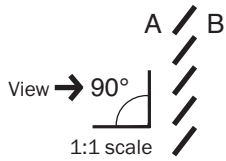
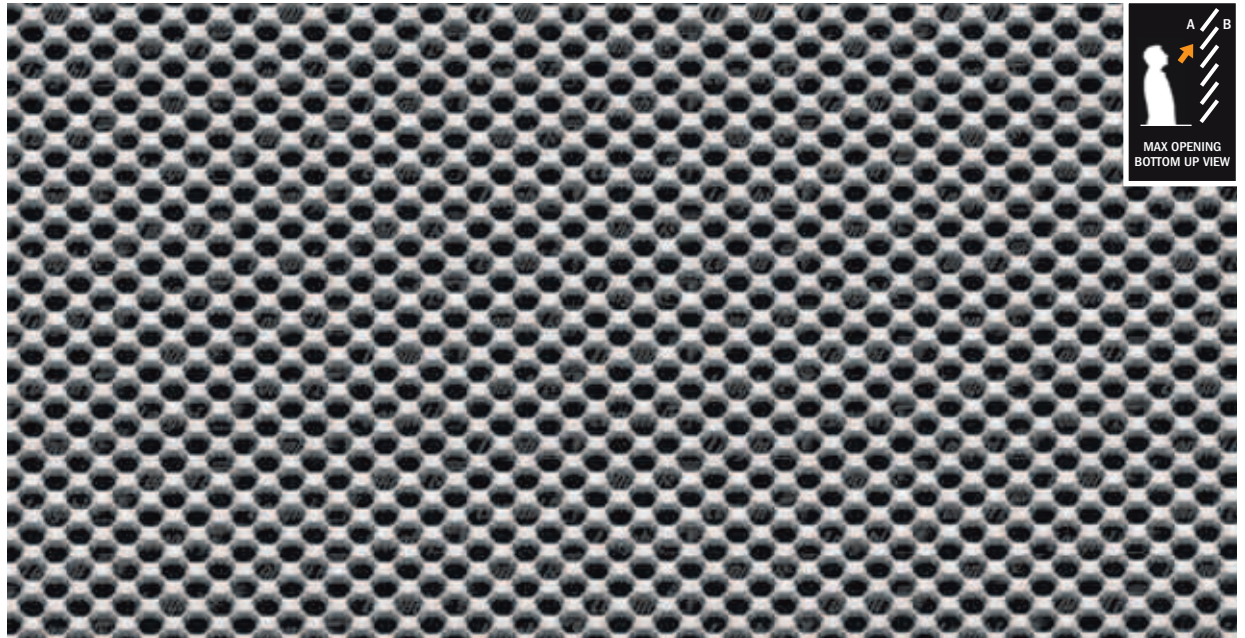

Type - LW - w x t - Ø (mm)	Mild steel (kg/m <sup>2</sup> )	Aluminium (kg/m <sup>2</sup> )	Available sheet size (mm)	Sheet thickness (mm)	% front open area
T 6 - 1.3 x <b>0.8</b> - Ø2.5	3.10	1.45	LW 1000 x SW 2000 LW 1250 x SW 2500	0.8 (~) ◆	43 (~)
T 6 - 1.3 x <b>1.0</b> - Ø2.5	3.90	1.65		1 (~) ◆	

- ◆ Measured at the centre,
- Framing profiles: see page 108

## T 6 - 1.3 x t - Ø2.5

|TYPE| LW |w| |t| |inscribed diameter hole

# TAU 20

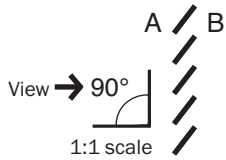
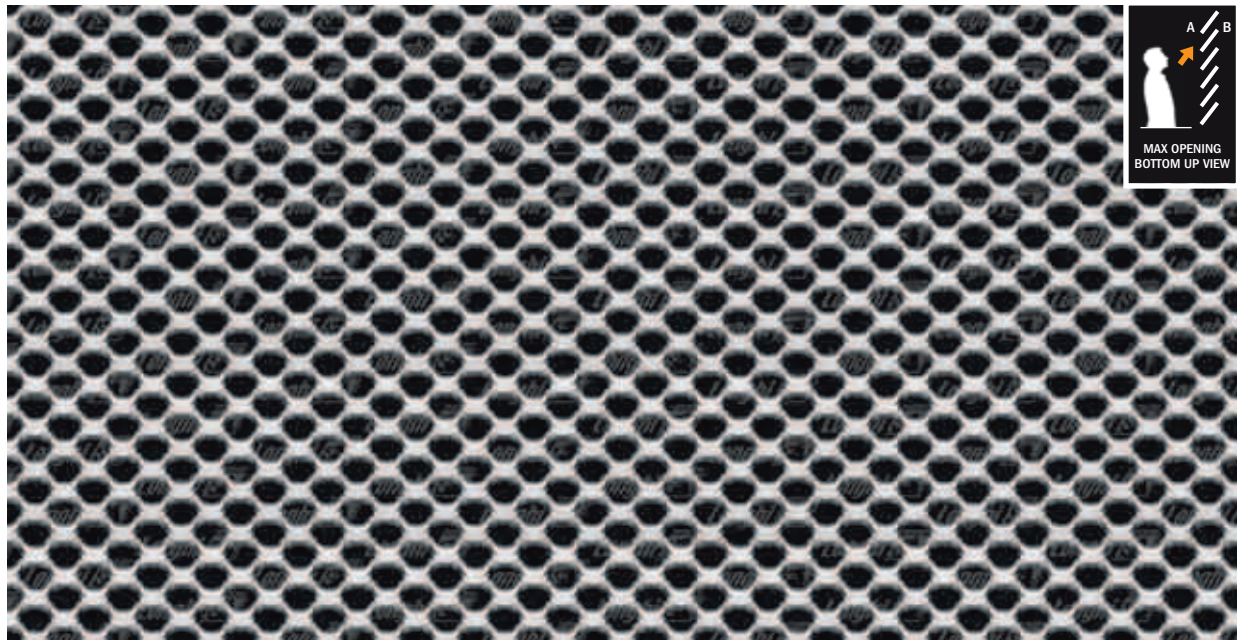

Type - LW - w x t - Ø (mm)	Mild steel (kg/m <sup>2</sup> )	Aluminium (kg/m <sup>2</sup> )	Available sheet size (mm)	Sheet thickness (mm)	% front open area
T 8 - 1.5 x <b>1.0</b> - Ø3	3.55	1.45	MS/t 1 LW 1000 x SW 2000 MS/t 1.5 LW 1250 x SW 2500 MS/t 1 LW 1250 x SW 2500 AL/ t 1.5 LW 1000 x SW 2000 MS/t 1 LW 1500 x SW 3000 AL/ t 1.5 LW 1250 x SW 2500 MS/t 1.5 LW 1000 x SW 2000 AL/ t 1.5 LW 1500 x SW 3000	1 (~) ◆	45 (~)
T 8 - 1.5 x <b>1.5</b> - Ø3	5.50	2.10		1.5 (~) ◆	

MS = Mild Steel - AL = Aluminium

- ◆ Measured at the centre,
- Framing profiles: see page 108

## T 8 - 1.5 x t - Ø3

|TYPE| LW |w| |t| |inscribed diameter hole



# TAU 30

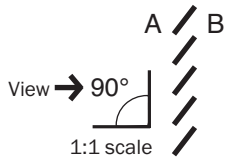
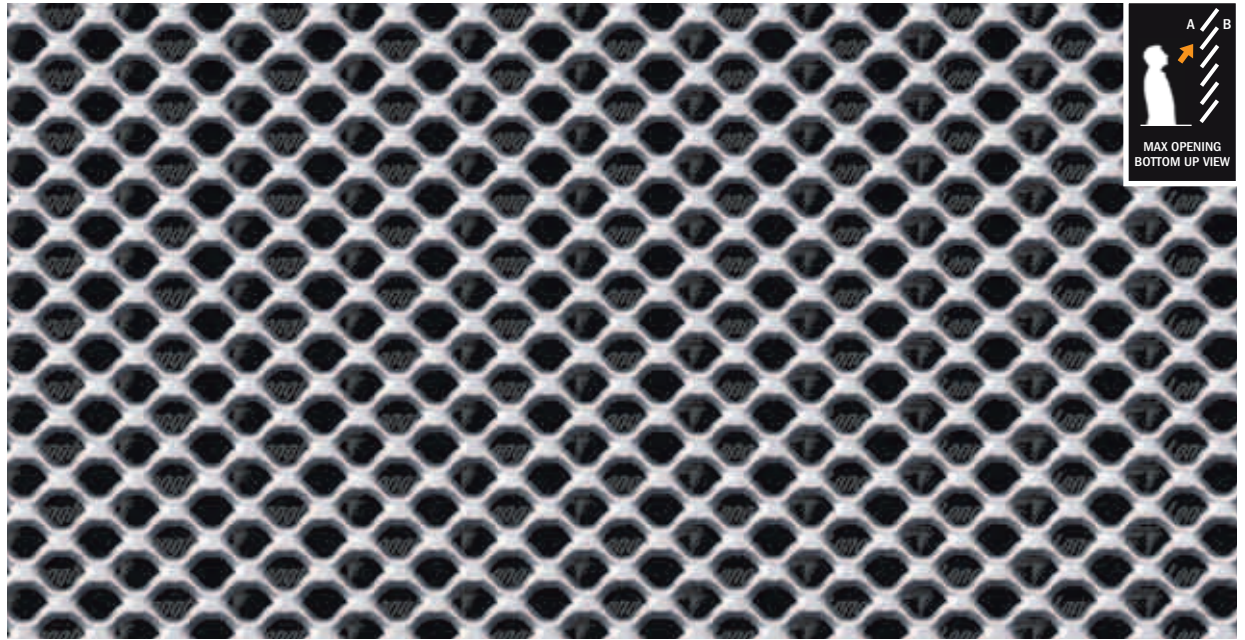

Type - LW - w x t - Ø (mm)	Mild steel (kg/m <sup>2</sup> )	Aluminium (kg/m <sup>2</sup> )	Available sheet size (mm)	Sheet thickness (mm)	% front open area
T 10 - 1.6 x 1.0 - Ø5	3.30	1.11	MS/AL t 1/1.5 DL 1000 x DC 2000	1 (~) ◆	50 (~)
T 10 - 1.6 x 1.5 - Ø5	4.90	1.70	MS/AL t 1/1.5 DL 1250 x DC 2500	1.5 (~) ◆	
T 10 - 1.6 x 2.0 - Ø5	6.50	2.40	MS/AL t 1/1.5 DL 1500 x DC 3000	2 (~) ◆	
			MS t 2 DL 1000 x DC 2000		
			AL/ t 2 DL 1250 x DC 2000		
			AL/ t 2 DL 1250 x DC 2500		
			AL/ t 2 DL 1500 x DC 3000		

MS = Mild Steel - AL = Aluminium

◆ Measured at the centre,  
● Framing profiles: see page 108

## T 10 - 1.6 x t - Ø5

|TYPE| LW | w | t | inscribed diameter hole

# TAU 40

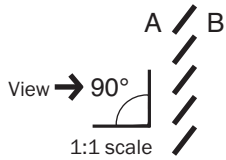
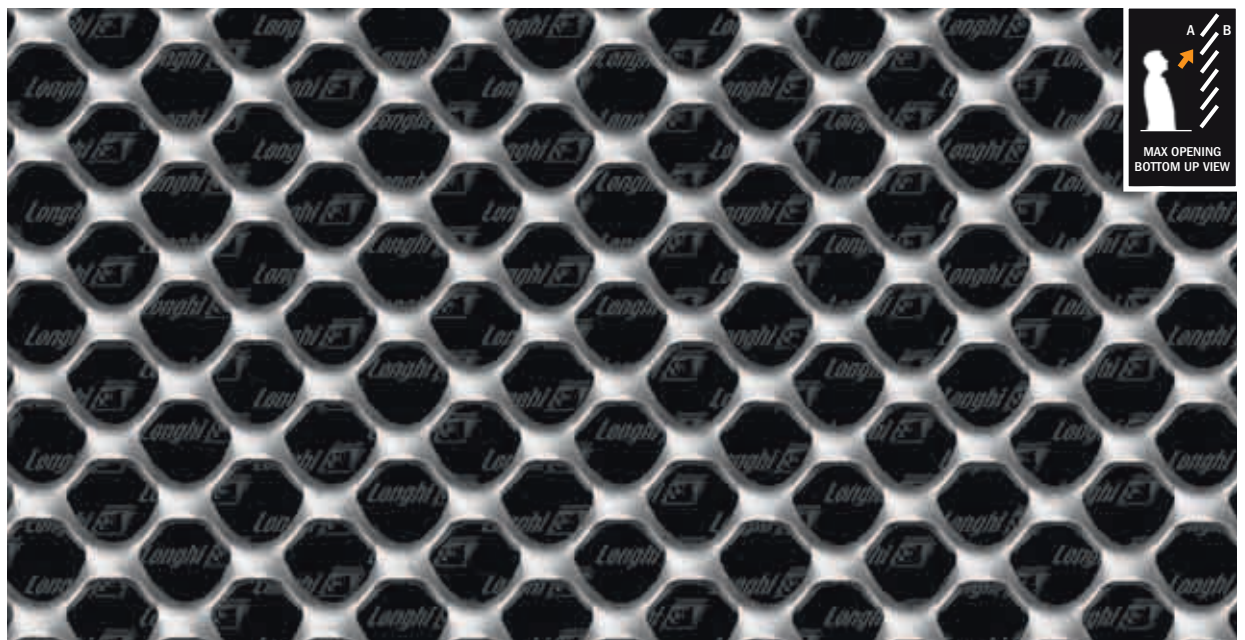

Type - LW - w x t - Ø (mm)	Mild steel (kg/m <sup>2</sup> )	Aluminium (kg/m <sup>2</sup> )	Available sheet size (mm)	Sheet thickness (mm)	% front open area
T 20 - 3.25 x 1.5 - Ø10	5.40	1.95	LW 1000 x SW 2000	5 (~) ◆	57 (~)
T 20 - 3.25 x 2.0 - Ø10	7.10	2.50	LW 1250 x SW 2500		
			LW 1500 x SW 3000		

◆ Measured at the centre,  
● Framing profiles: see page 108

## T 20 - 3.25 x t - Ø10

|TYPE| LW | w | t | inscribed diameter hole



# TAU 50

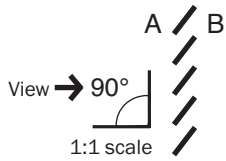
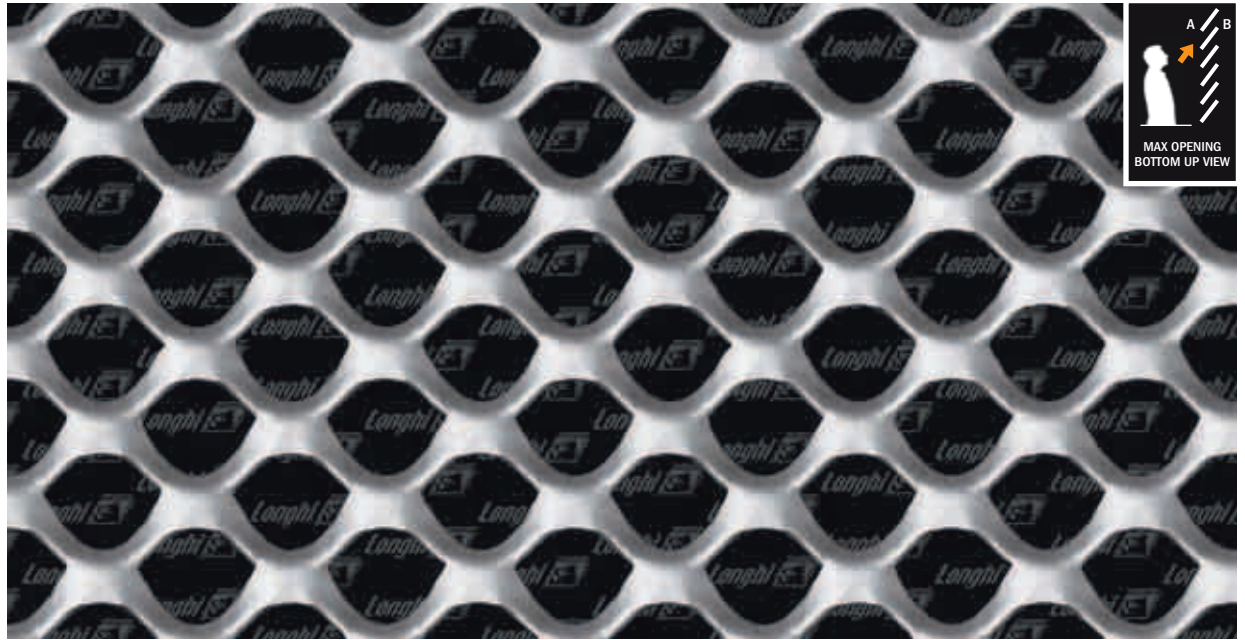

Type - LW - w x t - Ø (mm)	Mild steel (kg/m <sup>2</sup> )	Aluminium (kg/m <sup>2</sup> )	Available sheet size (mm)	Sheet thickness (mm)	% front open area
T 25 - 4.5 x 1.5 - Ø13	6.00	2.10	MS/t 1.5/2 LW 1000 x SW 2000 AL/t 1.5/2/3 LW 1000 x SW 2000	5 (~) ◆	51 (~)
T 25 - 4.5 x 2.0 - Ø13	7.80	2.70	MS/t 1.5/2 LW 1250 x SW 2500 AL/t 1.5/2/3 LW 1250 x SW 2500		
T 25 - 4.5 x 3.0 - Ø13	11.20	4.10	MS/t 3 LW 1000 x SW 2000 AL/t 1.5/2/3 LW 1500 x SW 3000		

MS = Mild Steel - AL = Aluminium

◆ Measured at the centre,  
● Framing profiles: see page 108

## T 25 - 4.5 x t - Ø13

|TYPE| LW | w | t | inscribed diameter hole

# TAU 60

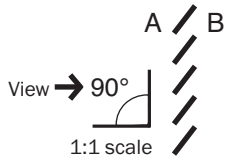

Type - LW - w x t - Ø (mm)	Mild steel (kg/m <sup>2</sup> )	Aluminium (kg/m <sup>2</sup> )	Available sheet size (mm)	Sheet thickness (mm)	% front open area
T 30 - 6 x 2.0 - Ø15	8.40	2.80	MS/t 2 LW 1000 x SW 2000 AL/t 2/3 LW 1000 x SW 2000	6 (~) ◆	51 (~)
T 30 - 6 x 3.0 - Ø15	11.50	3.65	MS/t 2 LW 1250 x SW 2500 AL/t 2/3 LW 1250 x SW 2500		
			MS/t 3 LW 1000 x SW 2000 AL/t 2/3 LW 1500 x SW 3000		

MS = Mild Steel - AL = Aluminium

◆ Measured at the centre,  
● Framing profiles: see page 108

## T 30 - 6 x t - Ø15

|TYPE| LW | w | t | inscribed diameter hole

# TAU 70

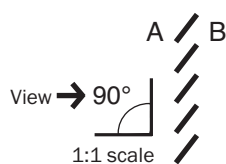
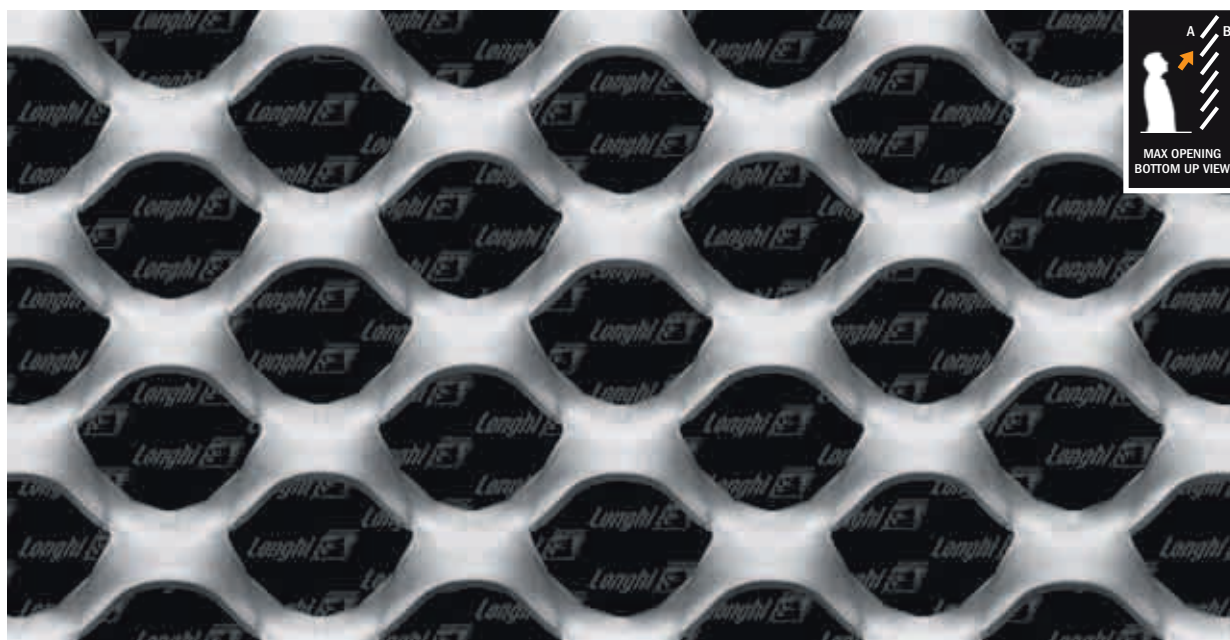

Type - LW - w x t - Ø (mm)
T 40 - 6.5 x <b>1.5</b> - Ø20
T 40 - 6.5 x <b>2.0</b> - Ø20
T 40 - 6.5 x <b>3.0</b> - Ø20

Mild steel (kg/m <sup>2</sup> )	Aluminium (kg/m <sup>2</sup> )
6.20	
8.30	
	3.80

Available sheet size (mm)	
MS/t 1.5/2 DL 1000 x DC 2000	AL/t 3 DL 1000 x DC 2000
MS/t 1.5/2 DL 1250 x DC 2500	AL/t 3 DL 1250 x DC 2500
	AL/t 3 DL 1500 x DC 3000

Sheet thickness (mm)	% front open area
10 (~) ◆	52 (~)

MS = Mild Steel - AL = Aluminium

- ◆ Measured at the centre,
- Framing profiles: see page 108

## T 40 - 6.5 x t - Ø20

|TYPE| LW | w | t | inscribed diameter hole

# KD 100

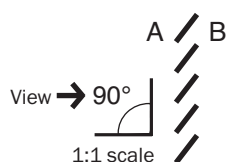

Type - LW x SW - w x t (mm)	Mild steel (kg/m <sup>2</sup> )	Aluminium (kg/m <sup>2</sup> )	Available sheet size (mm)	Sheet thickness (mm)	% front open area
Q 6 x 4.5 - 1.2 x 1*	4.15	1.50	LW 1000 x SW 2000 LW 1250 x SW 2500	1.5 (~) ◆	36 (~)

\*Mesh panels recommended for mold

- ◆ Measured at the centre,
- Framing profiles: see page 108

**Q 6 x 4.5 - 1.2 x t**  
 |TYPE| LW | SW | w | t

# KD 200

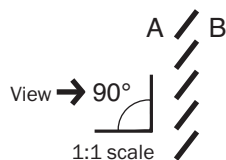
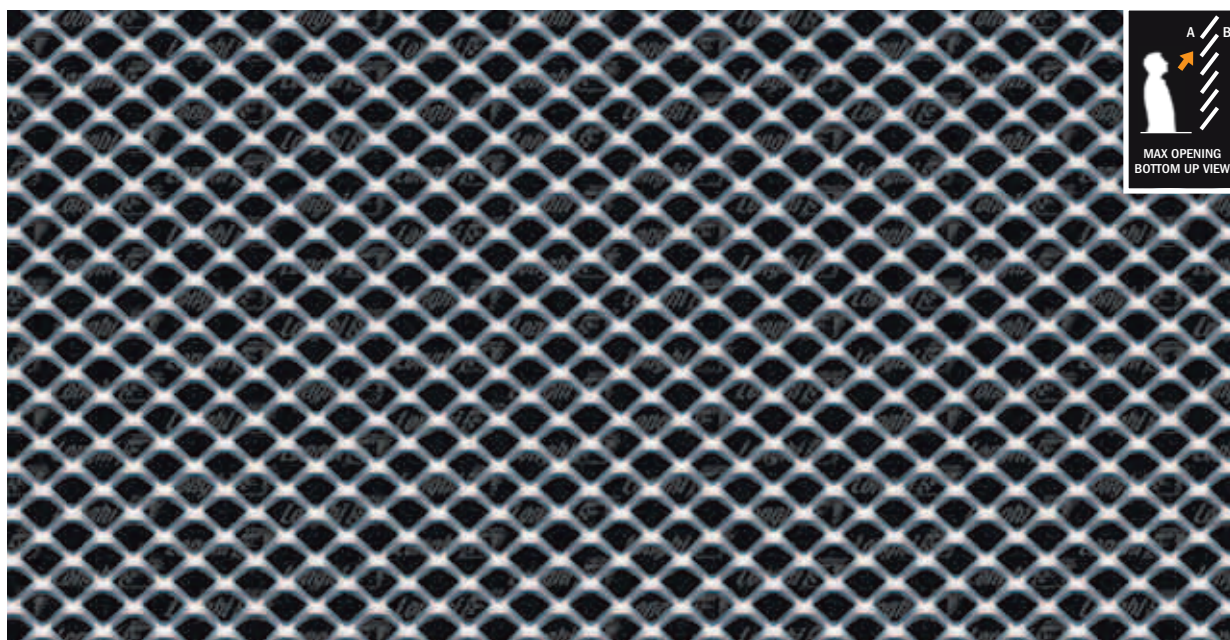

Type - LW x SW - w x t (mm)	Mild steel (kg/m <sup>2</sup> )	Aluminium (kg/m <sup>2</sup> )	Available sheet size (mm)	Sheet thickness (mm)	% front open area
Q 8 x 6 - 1.2 x 1*	3.15	1.10	LW 1000 x SW 2000 LW 1250 x SW 2500	2 (~) ◆	54 (~)

\*Mesh panels recommended for mold

- ◆ Measured at the centre,
- Framing profiles: see page 108

**Q 8 x 6 - 1.2 x t**  
 |TYPE| LW | SW | w | t

# KD 300

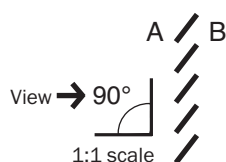
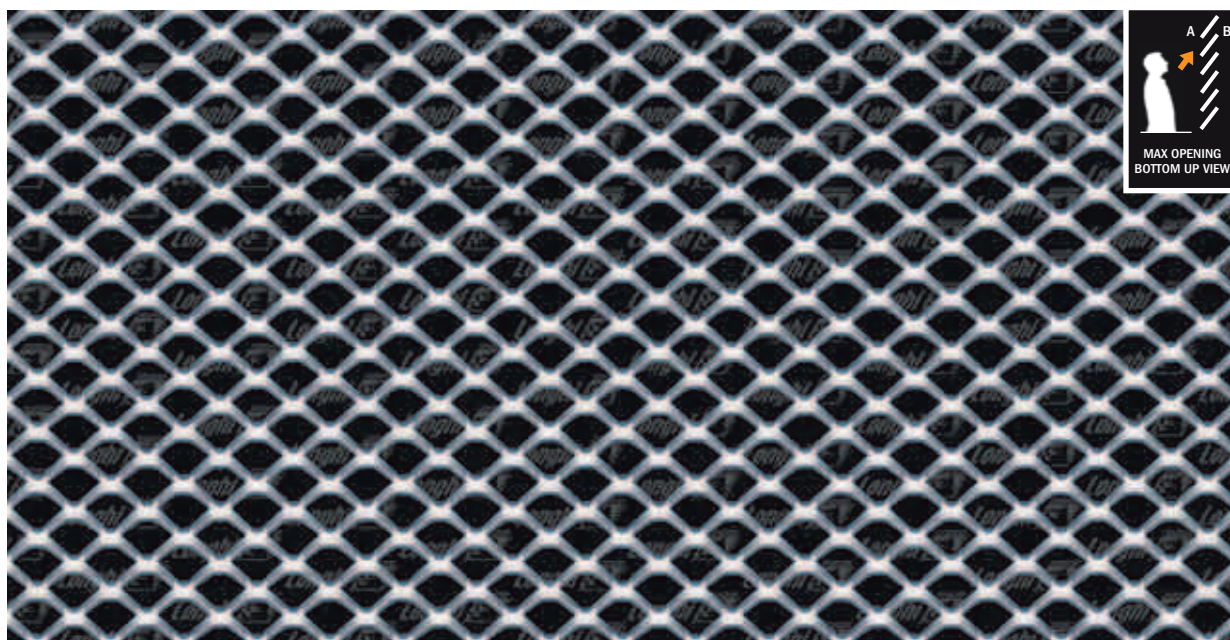

Type - LW x SW - w x t (mm)
Q 10 x 7 - 1.5 x 1*

Mild steel (kg/m <sup>2</sup> )
3.20

Aluminium (kg/m <sup>2</sup> )
1.10

Available sheet size (mm)
LW 1000 x SW 2000 LW 1250 x SW 2500

Sheet thickness (mm)
2 (~) ◆

% front open area
57 (~)

\*Mesh panels recommended for mold

- ◆ Measured at the centre,
- Framing profiles: see page 108

**Q 10 x 7 - 1.5 x t**  
|TYPE| LW |SW| w |t

# KD 400

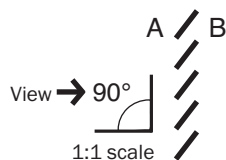
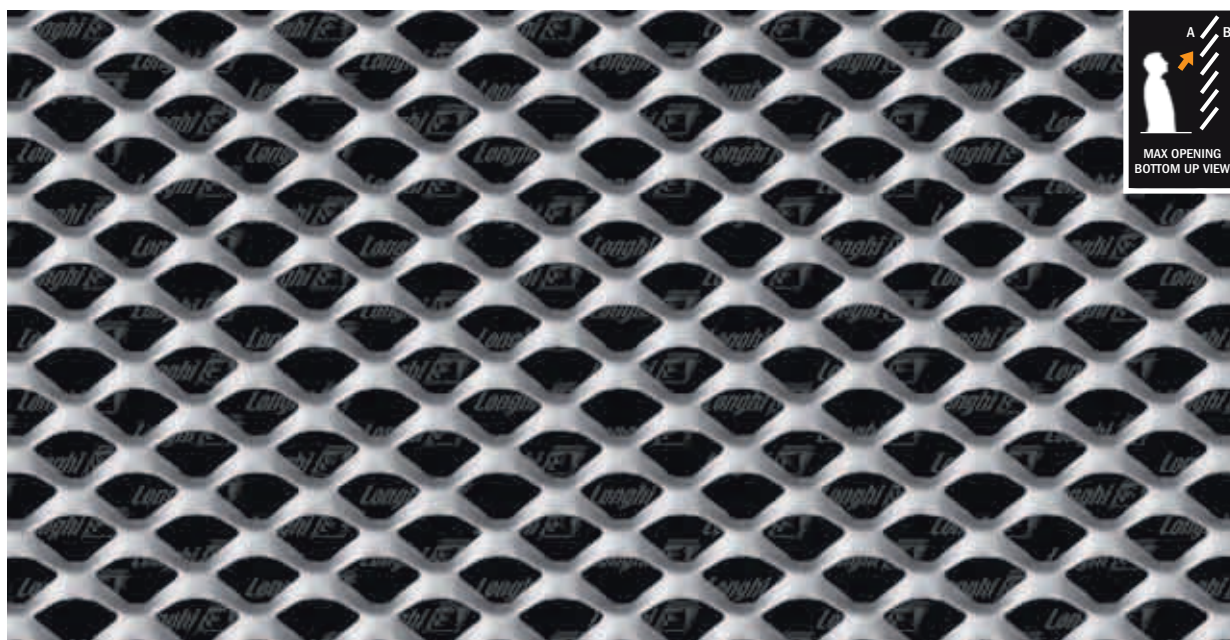

Type - LW x SW - w x t (mm)
Q 16 x 11 - 3 x 1.5
Q 16 x 11 - 3 x 2.0

Mild steel (kg/m <sup>2</sup> )
6.40
8.60

Aluminium (kg/m <sup>2</sup> )
2.25
3.00

Available sheet size (mm)
LW 1000 x SW 2000 LW 1250 x SW 2500 LW 1500 x SW 3000

Sheet thickness (mm)
4 (~) ◆

% front open area
46 (~)

- ◆ Measured at the centre,
- Framing profiles: see page 108

**Q 16 x 11 - 3 x t**  
|TYPE| LW |SW| w |t



# RB 15

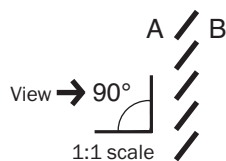
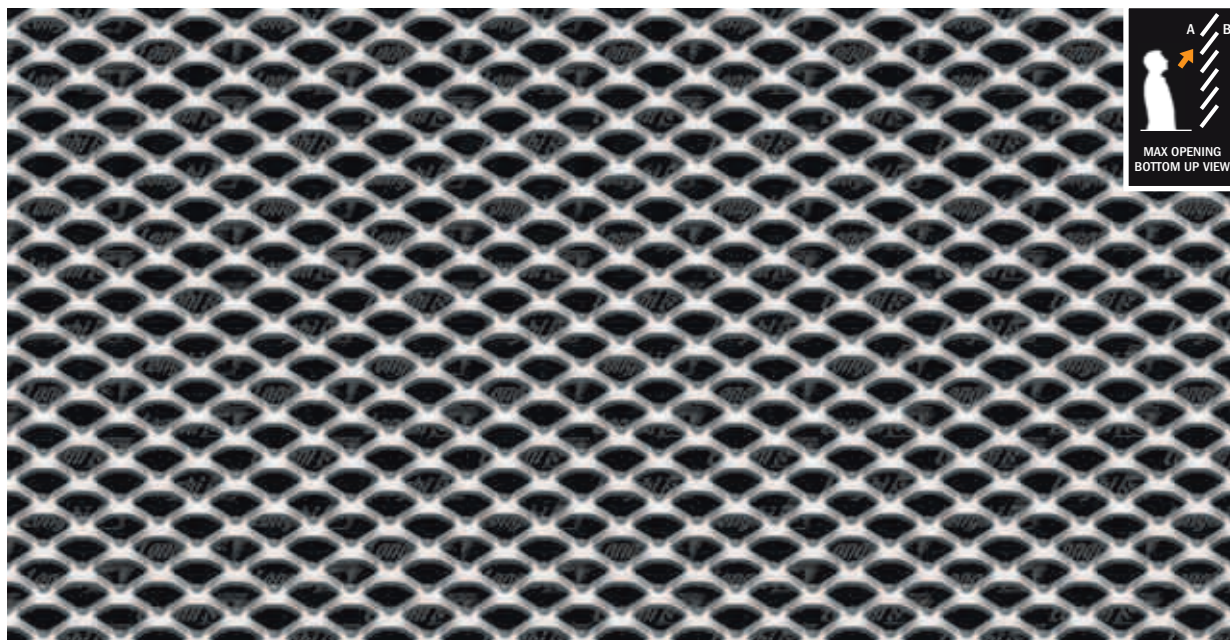

Type - LW x SW - w x t (mm)
R 10 x 5.8 - 1.5 x 1*

Mild steel (kg/m <sup>2</sup> )
4.10

Aluminium (kg/m <sup>2</sup> )
1.40

Available sheet size (mm)
LW 1000 x SW 2000
LW 1250 x SW 2500
LW 1500 x SW 3000

Sheet thickness (mm)
2 (~) ◆

% front open area
45 (~)

\*Mesh panels recommended for mold

- ◆ Measured at the centre,
- Framing profiles: see page 108

**R 10 x 5.8 - 1,5 x t**

|TYPE| LW      |SW      |w      |t

# RB 25

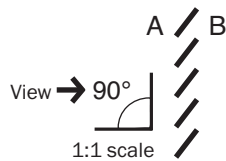
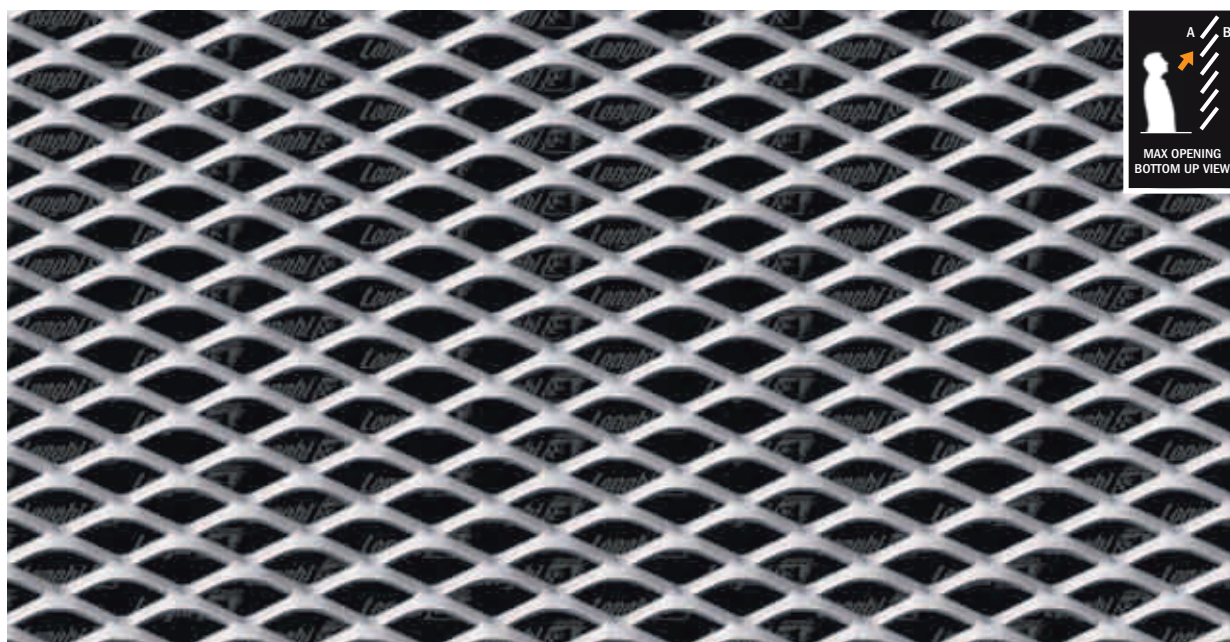

Type - LW x SW - w x t (mm)
R 16 x 8 - 2 x 1*

Mild steel (kg/m <sup>2</sup> )
4.00

Aluminium (kg/m <sup>2</sup> )
1.40

Available sheet size (mm)
LW 1000 x SW 2000
LW 1250 x SW 2500
LW 1500 x SW 3000

Sheet thickness (mm)
3 (~) ◆

% front open area
47 (~)

\*Mesh panels recommended for mold

- ◆ Measured at the centre,
- Framing profiles: see page 108

**R 16 x 8 - 2 x t**

|TYPE| LW      |SW      |w      |t

# RB 35

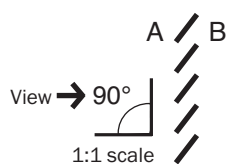
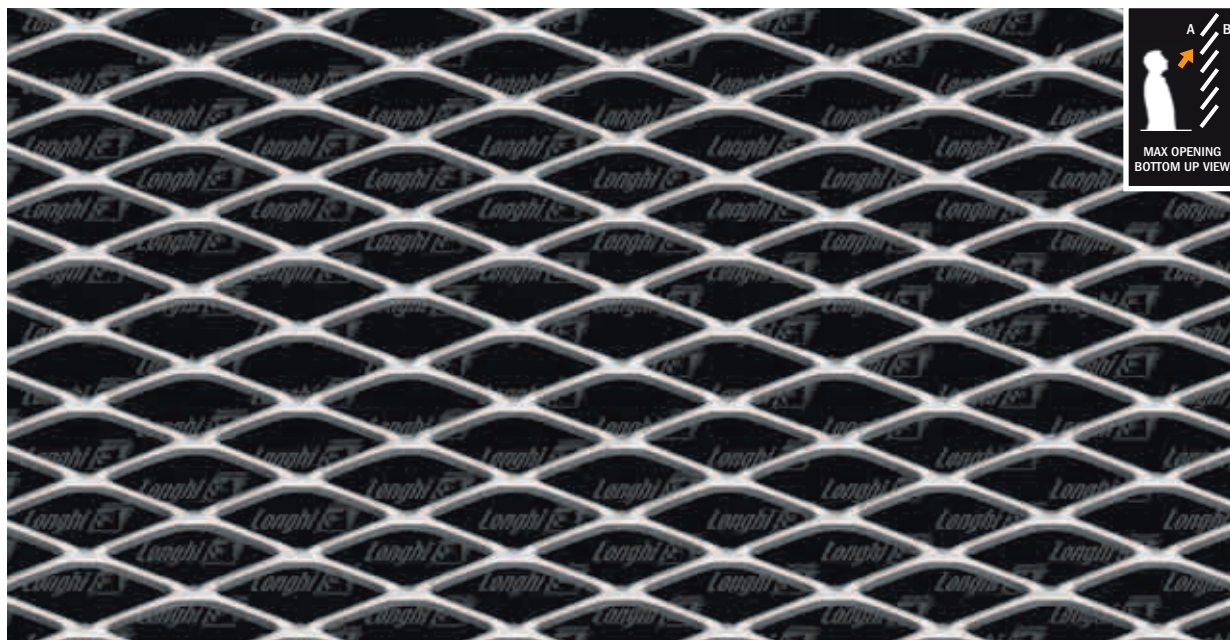

Type - LW x SW - w x t (mm)	Mild steel (kg/m <sup>2</sup> )	Aluminium (kg/m <sup>2</sup> )	Available sheet size (mm)	Sheet thickness (mm)	% front open area
R 28 x 10 - 2 x 1.5	4.80	1.70	LW 1000 x SW 2000 LW 1250 x SW 2500 LW 1500 x SW 3000	3.5 (~) ◆	55 (~)

- ◆ Measured at the centre,
- Framing profiles: see page 108

**R 28 x 10 - 2 x t**

|TYPE| LW | SW | w | t

# RB 45

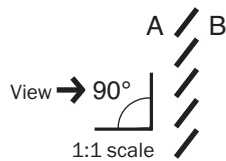
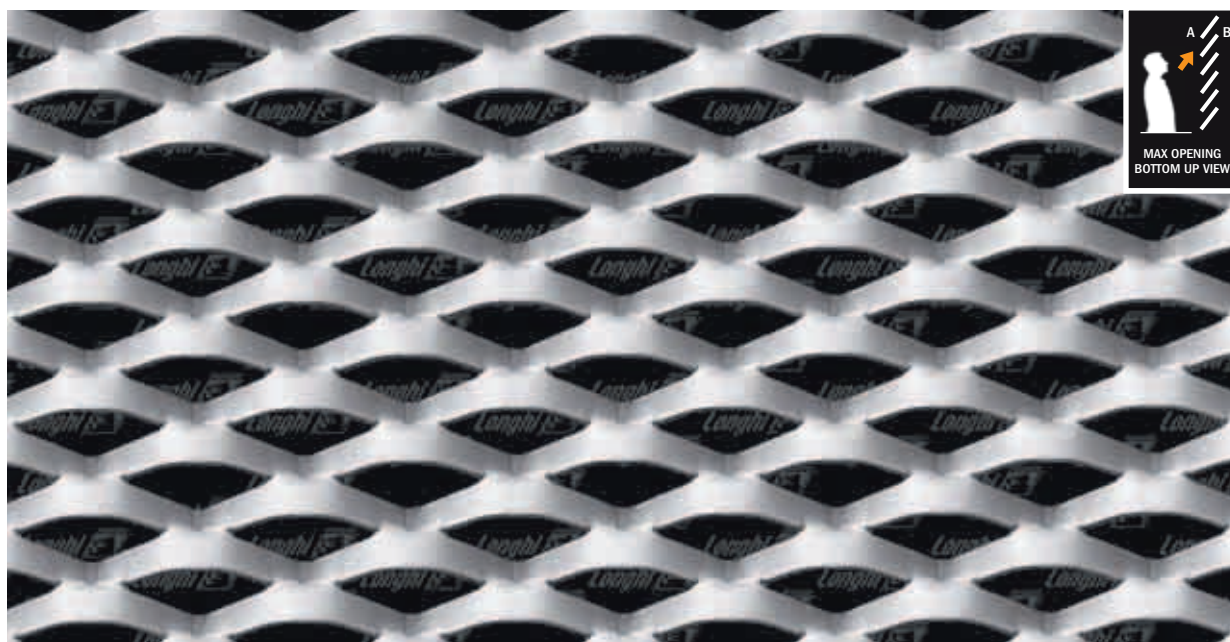

Type - LW x SW - w x t (mm)	Mild steel (kg/m <sup>2</sup> )	Aluminium (kg/m <sup>2</sup> )	Available sheet size (mm)	Sheet thickness (mm)	% front open area
R 28 x 14 - 5 x 1.5	8.40	3.00	LW 1000 x SW 2000 LW 1250 x SW 2500 LW 1500 x SW 3000	7 (~) ◆	33 (~)
R 28 x 14 - 5 x 2.0	11.30	3.90			

- ◆ Measured at the centre,
- Framing profiles: see page 108

**R 28 x 14 - 5 x t**

|TYPE| LW | SW | w | t



# RB 55

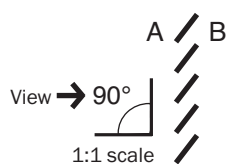
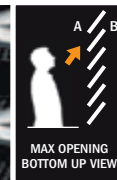

Type - LW x SW - w x t (mm)
R 43 x 13 - 2.5 x <b>1.5</b>
R 43 x 13 - 2.5 x <b>2.0</b>

Mild steel (kg/m <sup>2</sup> )
4.35
5.50

Aluminium (kg/m <sup>2</sup> )
1.40
2.10

Available sheet size (mm)
LW 1000 x SW 2000
LW 1250 x SW 2500
LW 1500 x SW 3000

Sheet thickness (mm)
4 (~) ◆

% front open area
60 (~)

- ◆ Measured at the centre,
- Framing profiles: see page 108

**R 43 x 13 - 2.5 x t**

|TYPE| LW | SW | w | t

# RB 65

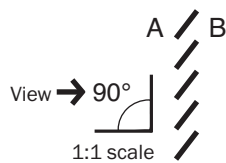
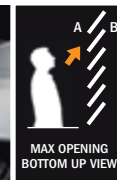

Type - LW x SW - w x t (mm)
R 62 x 23 - 8 x <b>0.6</b>
R 62 x 23 - 8 x <b>1.0</b>
R 62 x 23 - 8 x <b>1.5</b>

Mild steel (kg/m <sup>2</sup> )
3.35
5.60
8.20

Aluminium (kg/m <sup>2</sup> )
1.15
1.90
2.80

Available sheet size (mm)
LW 1000 x SW 2000
LW 1250 x SW 2500
LW 1500 x SW 3000

Sheet thickness (mm)
10 (~) ◆

% front open area
36 (~)

- ◆ Measured at the centre,
- Framing profiles: see page 108

**R 62 x 23 - 8 x t**

|TYPE| LW | SW | w | t



# RB 75

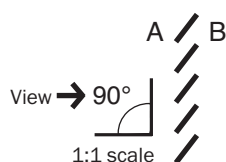

Type - LW x SW - w x t (mm)
R 85 x 35 - 11 x 1.5
R 85 x 35 - 11 x 2.0

Mild steel (kg/m <sup>2</sup> )
7.40
9.87

Aluminium (kg/m <sup>2</sup> )
2.55
3.40

Available sheet size (mm)
LW 1000 x SW 2000
LW 1250 x SW 2500
LW 1500 x SW 3000

Sheet thickness (mm)
14 (~) ◆

% front open area
48 (~)

- ◆ Measured at the centre,
- Framing profiles: see page 108

**R 85 x 35 - 11 x t**  
 |TYPE| LW | SW | w | t

# RB 85

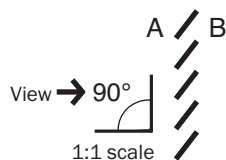

Type - LW x SW - w x t (mm)
R 100 x 35 - 11 x 1.5
R 100 x 35 - 11 x 2.0

Mild steel (kg/m <sup>2</sup> )
7.55
10.10

Aluminium (kg/m <sup>2</sup> )
2.70
3.50

Available sheet size (mm)
LW 1000 x SW 2000 on request
LW 1250 x SW 2500 on request
LW 1500 x SW 3000 on request

Sheet thickness (mm)
15 (~) ◆

% front open area
45 (~)

- ◆ Measured at the centre,
- Framing profiles: see page 108

**R 100 x 35 - 11 x t**  
 |TYPE| LW | SW | w | t



# Exa 04

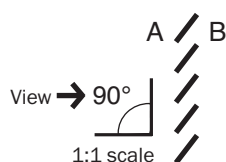

Type - LW x SW - w x t (mm)
E 40 x 20 - 7 x 1.5
E 40 x 20 - 7 x 2.0

Mild steel (kg/m <sup>2</sup> )	Aluminium (kg/m <sup>2</sup> )
8.30	2.90
11.00	3.80

Available sheet size (mm)
LW 1000 x SW 2000
LW 1250 x SW 2500
LW 1500 x SW 3000

Sheet thickness (mm)
8 (~) ◆

% front open area
37 (~)

- ◆ Measured at the centre,
- Framing profiles: see page 108

**E 40 x 20 - 7 x t**  
 |TYPE| LW |SW |w |t

# Exa 05

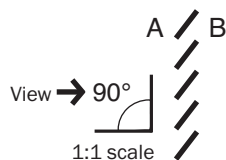

Type - LW x SW - w x t (mm)
E 50 x 23 - 8 x 1.5
E 50 x 23 - 8 x 2.0

Mild steel (kg/m <sup>2</sup> )	Aluminium (kg/m <sup>2</sup> )
8.20	2.85
10.95	3.75

Available sheet size (mm)
LW 1000 x SW 2000 on request
LW 1250 x SW 2500 on request
LW 1500 x SW 3000 on request

Sheet thickness (mm)
10 (~) ◆

% front open area
43 (~)

- ◆ Measured at the centre,
- Framing profiles: see page 108

**E 50 x 23 - 8 x t**  
 |TYPE| LW |SW |w |t

# Exa 12

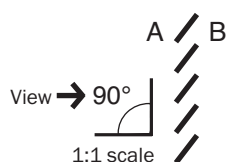

Type - LW x SW - w x t (mm)
E 80 x 30 - 9 x 1.5
E 80 x 30 - 9 x 2.0

Mild steel (kg/m <sup>2</sup> )	Aluminium (kg/m <sup>2</sup> )
7.10	2.50
9.50	3.30

Available sheet size (mm)
LW 1000 x SW 2000
LW 1250 x SW 2500
LW 1500 x SW 3000

Sheet thickness (mm)
12 (~) ◆

% front open area
54 (~)

- ◆ Measured at the centre,
- Framing profiles: see page 108

**E 80 x 30 - 9 x t**  
 |TYPE| LW | SW | w | t

# Exa 16

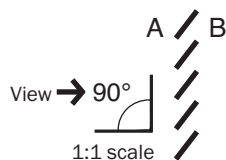

Type - LW x SW - w x t (mm)
E 80 x 30 - 13 x 1.5
E 80 x 30 - 13 x 2.0

Mild steel (kg/m <sup>2</sup> )	Aluminium (kg/m <sup>2</sup> )
10.20	3.60
13.70	4.70

Available sheet size (mm)
LW 1000 x SW 2000
LW 1250 x SW 2500
LW 1500 x SW 3000

Sheet thickness (mm)
11 (~) ◆

% front open area
15 (~)

- ◆ Measured at the centre,
- Framing profiles: see page 108

**E 80 x 30 - 13 x t**  
 |TYPE| LW | SW | w | t



# Deco 91

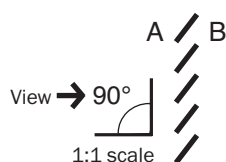

Type - LW x SW - w x t (mm)	Mild steel (kg/m <sup>2</sup> )	Aluminium (kg/m <sup>2</sup> )	Available sheet size (mm)	Sheet thickness (mm)	% front open area
E 45 x 8 - 3.5 x <b>1.0</b>	6.80	2.40	LW 1000 x SW 2000 LW 1250 x SW 2500 LW 1500 x SW 3000	4 (~) ◆	23 (~)
E 45 x 8 - 3.5 x <b>1.5</b>	10.00	3.30			

- ◆ Measured at the centre,
- Framing profiles: see page 108

**E 45 x 8 - 3.5 x t**

|TYPE| LW | SW | w | t

# Residence

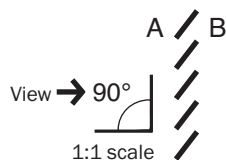

Type - LW x SW - w x t (mm)	Mild steel (kg/m <sup>2</sup> )	Aluminium (kg/m <sup>2</sup> )	Available sheet size (mm)	Sheet thickness (mm)	% front open area
E 45 x 18 - 8 x <b>1.5</b>	10.50	3.60	MS/t 1.5 LW 1000 x SW 2000 MS/t 2 LW 1250 x SW 2500 MS/t 1.5 LW 1250 x SW 2500 AL/ t 1.5/2 LW 1000 x SW 2000 MS/t 1.5 LW 1500 x SW 3000 AL/ t 1.5/2 LW 1250 x SW 2500 MS/t 2 LW 1000 x SW 2000 AL/ t 1.5/2 LW 1500 x SW 3000	7 (~) ◆	11 (~)
E 45 x 18 - 8 x <b>2.0</b>	14.00	4.80			

MS = Mild Steel - AL = Aluminium

- ◆ Measured at the centre,
- Framing profiles: see page 108

**R 45 x 18 - 8 x t**

|TYPE| LW | SW | w | t

# Village

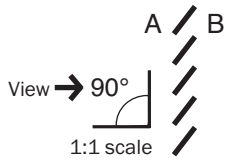
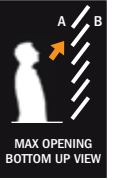
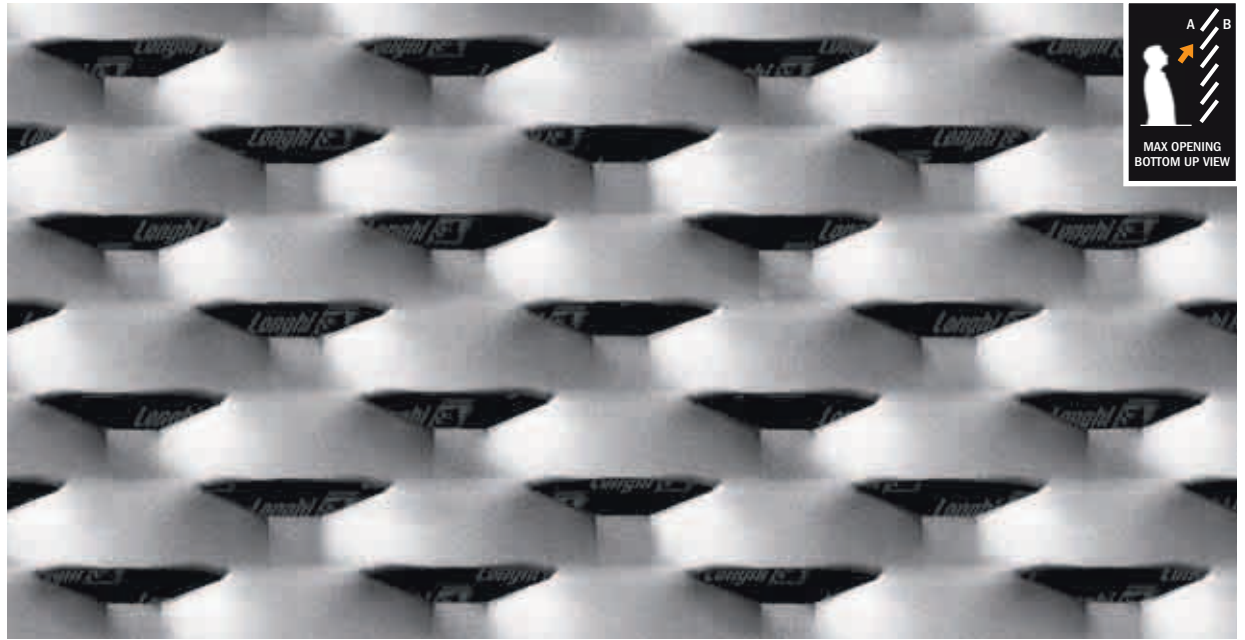

Type - LW x SW - w x t (mm)
R 43 x 23 - 10 x 1.5
R 43 x 23 - 10 x 2.0

Mild steel (kg/m <sup>2</sup> )
10.30
13.70

Aluminium (kg/m <sup>2</sup> )
3.50
4.70

Available sheet size (mm)			
MS/t 1.5 LW 1000 x SW 2000	MS/t 2 LW 1250 x SW 2500	AL/ t 1.5/2 LW 1000 x SW 2000	AL/ t 1.5/2 LW 1250 x SW 2500
MS/t 1.5 LW 1250 x SW 2500	MS/t 1.5 LW 1500 x SW 3000	MS/t 2 LW 1000 x SW 2000	AL/ t 1.5/2 LW 1500 x SW 3000

Sheet thickness (mm)	% front open area
8 (~) ◆	15 (~)

MS = Mild Steel - AL = Aluminium

- ◆ Measured at the centre,
- Framing profiles: see page 108

## R 43 x 23 - 10 x t

|TYPE| LW | SW | w | t

# Terrace

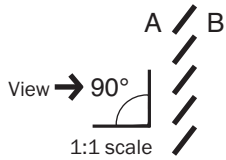
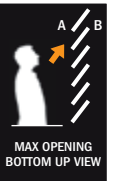
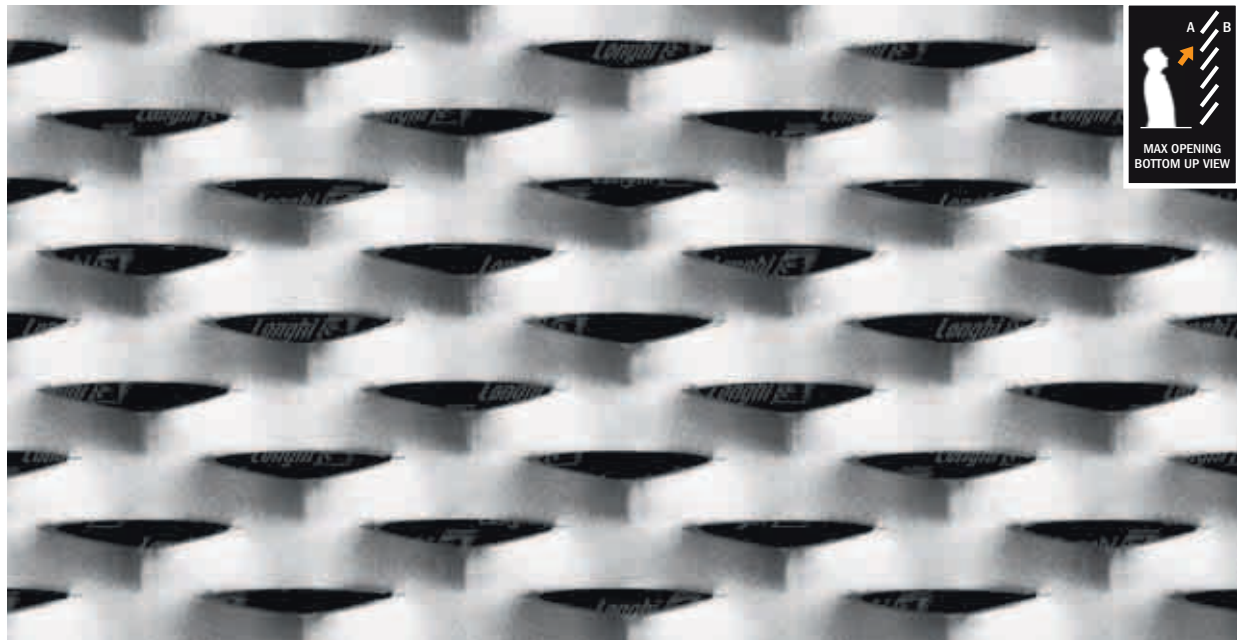

Type - LW x SW - w x t (mm)
R 43 x 18 - 8 x 1.5
R 43 x 18 - 8 x 2.0

Mild steel (kg/m <sup>2</sup> )
10.50
14.00

Aluminium (kg/m <sup>2</sup> )
3.60
4.60

Available sheet size (mm)			
MS/t 1.5 LW 1000 x SW 2000	MS/t 2 LW 1250 x SW 2500	AL/ t 1.5/2 LW 1000 x SW 2000	AL/ t 1.5/2 LW 1250 x SW 2500
MS/t 1.5 LW 1250 x SW 2500	MS/t 1.5 LW 1500 x SW 3000	MS/t 2 LW 1000 x SW 2000	AL/ t 1.5/2 LW 1500 x SW 3000

Sheet thickness (mm)	% front open area
6 (~) ◆	14 (~)

MS = Mild Steel - AL = Aluminium

- ◆ Measured at the centre,
- Framing profiles: see page 108

## R 43 x 18 - 8 x t

|TYPE| LW | SW | w | t

# Office

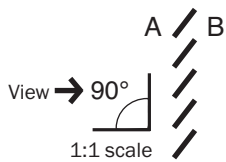
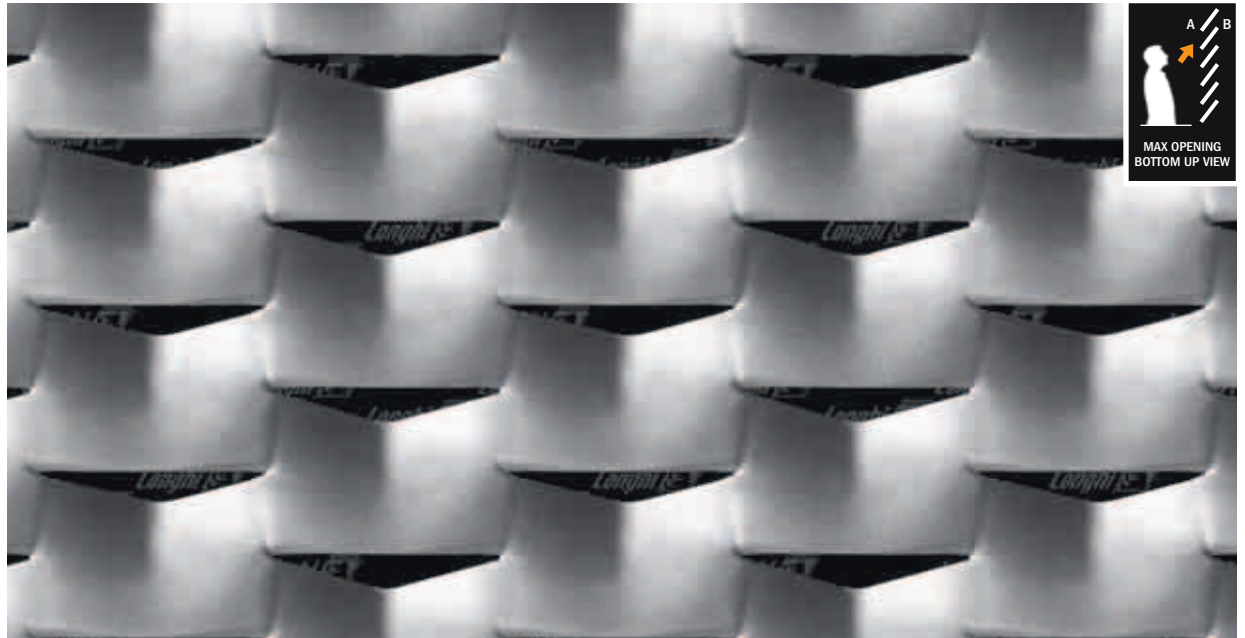

Type - LW x SW - w x t (mm)
R 62 x 22 - 10 x 1.5
R 62 x 22 - 10 x 2.0

Mild steel (kg/m <sup>2</sup> )
10.50

Aluminium (kg/m <sup>2</sup> )
3.60
4.90

Available sheet size (mm)	
MS/t 1.5 LW 1000 x SW 2000	AL/t 1.5/2 LW 1000 x SW 2000
MS/t 1.5 LW 1250 x SW 2500	AL/t 1.5/2 LW 1250 x SW 2500
	AL/t 1.5/2 LW 1500 x SW 3000

Sheet thickness (mm)	% front open area
9 (~) ◆	12 (~)

MS = Mild Steel - AL = Aluminium

- ◆ Measured at the centre,
- Framing profiles: see page 108

**R 62 x 22 - 10 x t**

|TYPE| LW | SW | w | t

# Palace

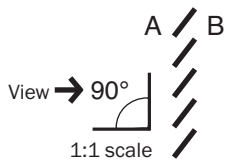

Type - LW x SW - w x t (mm)
R 85 x 30 - 13 x 1.5
R 85 x 30 - 13 x 2.0

Mild steel (kg/m <sup>2</sup> )
10.50
14.10

Aluminium (kg/m <sup>2</sup> )
3.60
4.80

Available sheet size (mm)	
MS/t 1.5 LW 1000 x SW 2000	MS/t 2 LW 1250 x SW 2500
MS/t 1.5 LW 1250 x SW 2500	AL/ t 1.5/2 LW 1000 x SW 2000
MS/t 1.5 LW 1500 x SW 3000	AL/ t 1.5/2 LW 1250 x SW 2500
MS/t 2 LW 1000 x SW 2000	AL/ t 1.5/2 LW 1500 x SW 3000

Sheet thickness (mm)	% front open area
11 (~) ◆	18 (~)

MS = Mild Steel - AL = Aluminium

- ◆ Measured at the centre,
- Framing profiles: see page 108

**R 85 x 30 - 13 x t**

|TYPE| LW | SW | w | t

# Country

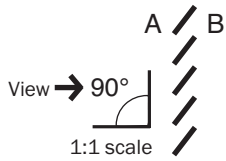

Type - LW x SW - w x t (mm)
R 100 x 30 - 11 x <b>1.5</b>
R 100 x 30 - 11 x <b>2.0</b>

Mild steel (kg/m <sup>2</sup> )
8.80
11.75

Aluminium (kg/m <sup>2</sup> )
3.00
4.00

Available sheet size (mm)
LW 1000 x SW 2000
LW 1250 x SW 2500
LW 1500 x SW 3000

Sheet thickness (mm)
14 (~) ◆

% front open area
30 (~)

- ◆ Measured at the centre,
- Framing profiles: see page 108

## R 100 x 30 - 11 x t

|TYPE| LW | SW | w | t

# Urban

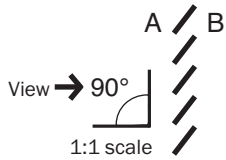

Type - LW x SW - w x t (mm)
R 100 x 30 - 13 x <b>1.5</b>
R 100 x 30 - 13 x <b>2.0</b>

Mild steel (kg/m <sup>2</sup> )
10.40
13.40

Aluminium (kg/m <sup>2</sup> )
3.55
4.70

Available sheet size (mm)
LW 1000 x SW 2000
LW 1250 x SW 2500
LW 1500 x SW 3000

Sheet thickness (mm)
13 (~) ◆

% front open area
17 (~)

- ◆ Measured at the centre,
- Framing profiles: see page 108

## R 100 x 30 - 13 x t

|TYPE| LW | SW | w | t



# R 43AS

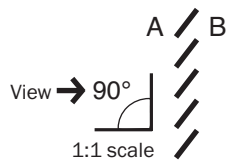
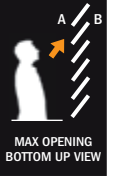
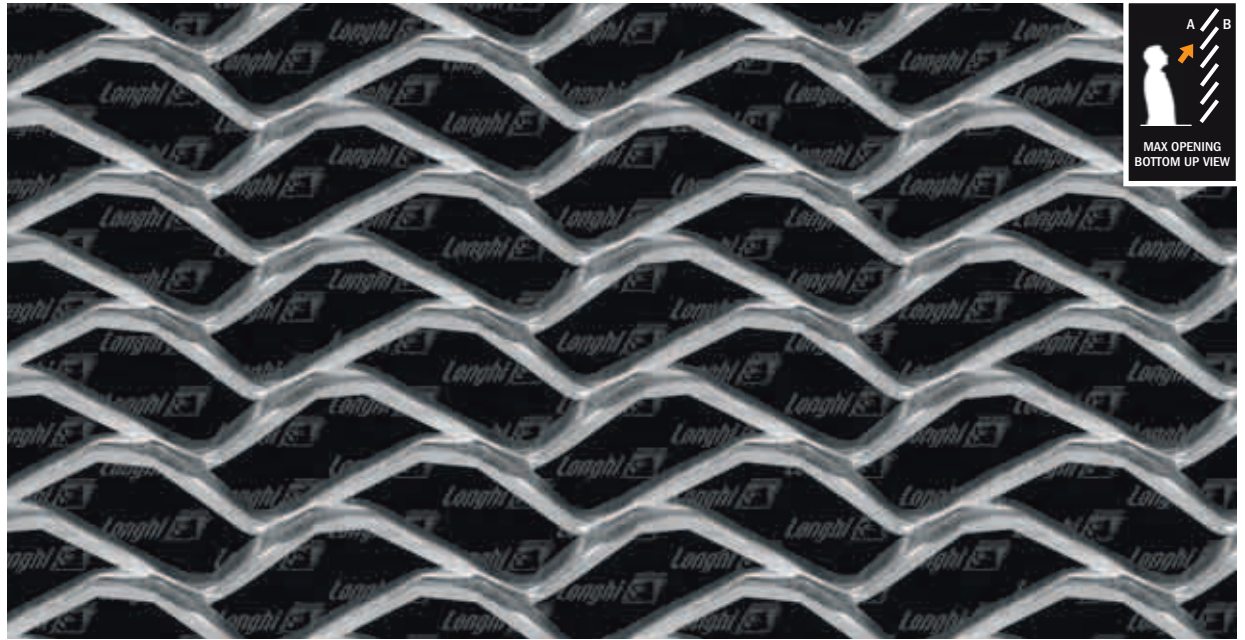

Type - LW x SW - w x t (mm)	Mild steel (kg/m <sup>2</sup> )	Aluminium (kg/m <sup>2</sup> )	Available sheet size (mm)	Sheet thickness (mm)	% front open area
R 43AS x 17 - 2.1 x <b>1.5</b>	2.95	1.00	LW 1000 x SW 2000 LW 1250 x SW 2500 LW 1500 x SW 3000	5 (~) ◆	36 (~)
R 43AS x 17 - 3.0 x <b>3.0</b>		2.90			

- ◆ Measured at the centre,
- Framing profiles: see page 108

## R 43AS x 17 - 2.1 x t

|TYPE| LW                      |SW      |w                      |t

# Ralf

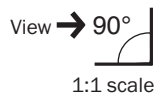
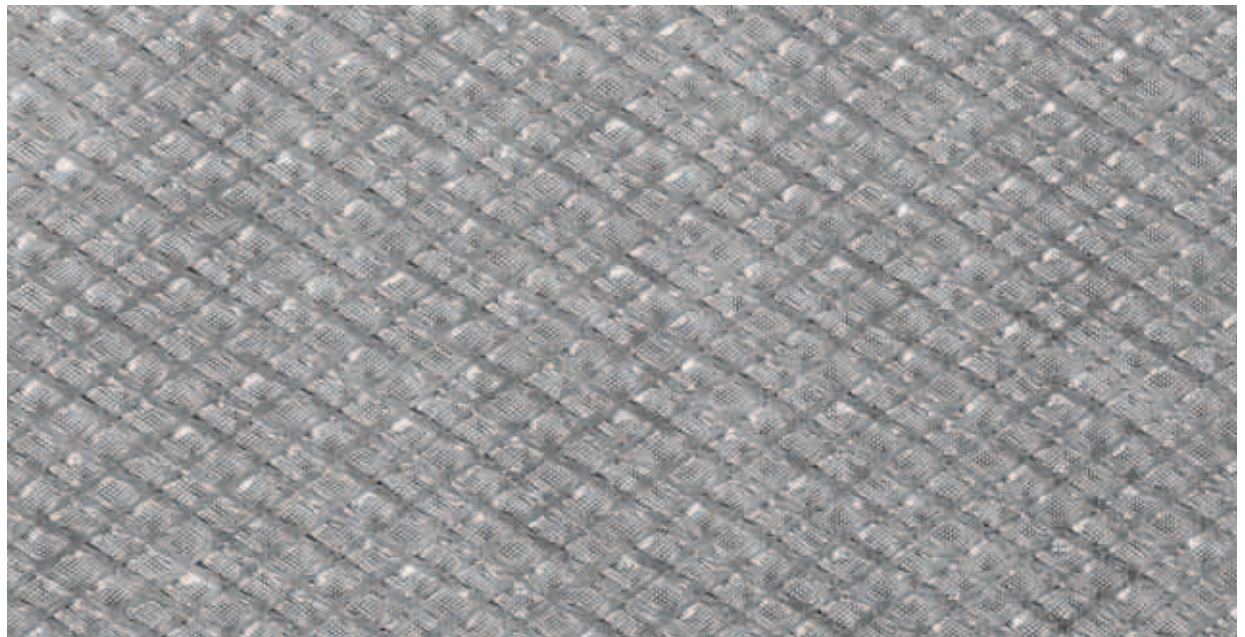

Multi-layer Aluminium mesh	Aluminium (kg/m <sup>2</sup> )	Coils (mm)	Sheet thickness (mm)
	3.05	LW 1000    LW 1250	1.4 (~)



## SPECIAL MATERIALS

Italfim can also produce its STILTECH line of expanded mesh using TECU® Copper, Zinc-Titanium and Corten® Steel.

Contact us for further information.



**TECU® Copper**  
expanded mesh



**Zinc-Titanium**  
expanded mesh

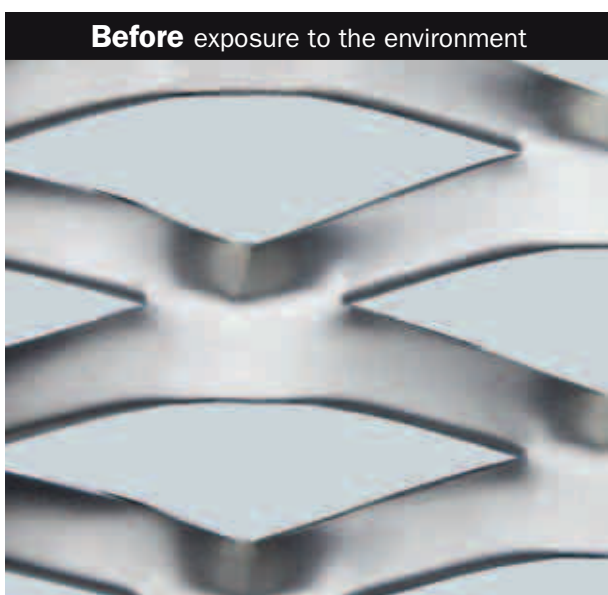

**Before** exposure to the environment

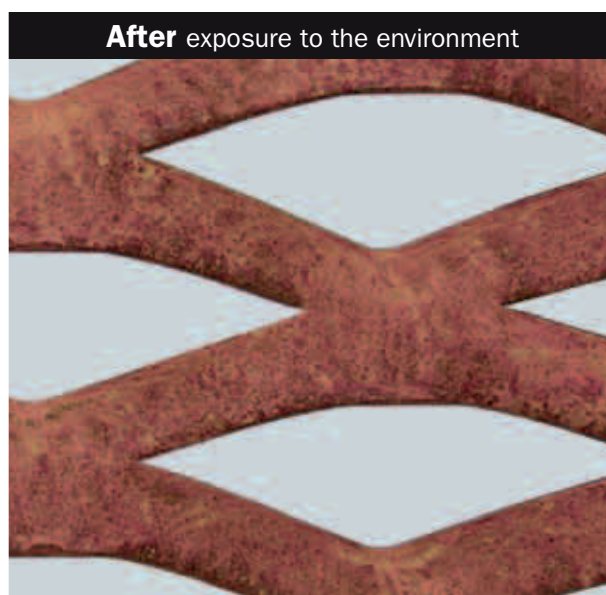

**After** exposure to the environment

**CORTEN® Steel**  
expanded mesh



**ITALFIM S.p.A. Expanded metal mesh and micromesh**

Single-member company subject  
to direction and coordination by L HOLDING S.r.l.

Via Tonale, 2 (Zona Industriale 1), angolo Via Crocette

24066 PEDRENGO (BG) Italy

Tel. +39 035 658 111 - Fax +39 035 656 050

International Fax +39 035 664 151

italfim@italfim.it - www.italfim.it

*Graphic designer*

Pierluigi Passarella

*Copywriting*

Anna Martinelli

*Cover Photo*

Pino Musi

**Disclaimer and Copyright**

The information provided in this publication has been thoroughly checked. Whenever mistakes or omissions are involuntarily made, the company reserves the right to make the corrections suggested in subsequent editions and as specified by copyright law. The graphics, images, and the texts provided herein cannot be copied or transmitted by any means or put to professional or commercial use without the previous written consent of the legitimate copyright holders.



# ARCHITECTURE



**archi**  
explorer

[www.archiexplorer.com](http://www.archiexplorer.com)



100 projects with expanded metal mesh  
STILTECH and PROTECH mesh  
ULTRA LIMITES line



**gira international**  
Architektur mit Metall

Auf der Schanz 30, A-2345 Brunn am Gebirge  
Telefon: +43 2236 315 198  
Mobil: +43 676 90 90 950  
office@gira-international.com  
www.gira-international.com

